

Firestone

A TRADITION OF INNOVATION



FIRESTONE INDUSTRIAL PRODUCTS CO., LLC
Corporate Headquarters

250 W. 96th STREET • INDIANAPOLIS, IN 46260
USA

TOLL FREE: 800.888.0650 • WWW.RIDE-RITE.COM

AIRBAG MAN

9 Hinkler Court
Brendale
Queensland 4500
Australia
Tel: 07 3889 6556
Fax: 07 3889 6557
Email: info@airbagman.com.au
Imported by:
Air Springs Supply Pty Ltd

DRIVERITE

Unit 626 Kilshane Avenue
North West Business Park
Ballycoolin
Dublin 15 Ireland
Tel: + 353 1 8612 632
Fax: + 353 1 8612 647
Email: sales@driveriteltd.com
info@driveriteltd.com
www.driveriteltd.com



Firestone

World's Number 1
Air Spring.



FIRESTONE INDUSTRIAL PRODUCTS COMPANY



Application Guide

2 0 1 1







We are proud members and support the efforts of the following trade associations:



Table of contents

- Applications 1-34
- R4Tech™ Applications 35-42
- Reverse Look-Up 43-47
- Air Accessory Systems 48-49
- Air Components-Air Compressors..... 50
- Air Springs 51-52
- Coil-Rite Air Springs..... 53
- Lift Spacers/Lifted & Lowered Kits..... 54
- Air Accessory Components 55
- Air Tanks 56-57
- Service Parts-Air Fitting & Air Line Tubing 58





All trademarks are the property of their respective owners.
Copyright © 2010 Firestone Industrial Products Company, LLC

MODEL	YEAR	Air Leveling Rear					Air Leveling Front				Work-Rite			Shocks		Recommended Air Accessory Systems		
		REAR KIT	TYPE		SPRING ONLY		FRONT KIT	TYPE		SPRING ONLY	FRONT KIT		REAR KIT		FRONT	REAR	SINGLE	DUAL
Acura SUVs																		
MDX	05-10	4179	C-R		6020												2158 / 2490	2178 / 2491
RDX	07-10	4133	C-R	ND	6018												2158 / 2490	2178 / 2491
Audi Cars																		
A3	10	4118	C-R	ND	6018												2158 / 2490	2178 / 2491
Buick Cars																		
Centurion	71-73	-4116-	C-R	ND	6010												2158 / 2490	2178 / 2491
Century (fwd only)	82-96	4103	C-R	ND	6014												2158 / 2490	2178 / 2491
Century (rwd only)	73-87	4114	C-R	ND	6008												2158 / 2490	2178 / 2491
Electra (not sw)	85-96	4107	C-R	ND	6021												2158 / 2490	2178 / 2491
Grand Sport	73-87	4114	C-R	ND	6008												2158 / 2490	2178 / 2491
LeSabre (not sw) (fwd only)	00-05	4105	C-R	ND	6013												2158 / 2490	2178 / 2491
LeSabre FWD	86-99	4107	C-R	ND	6021												2158 / 2490	2178 / 2491
LeSabre (rwd only)	85	-4116-	C-R	ND	6010												2158 / 2490	2178 / 2491
LeSabre Estate Wagon	77-90	-4116-	C-R	ND	6010												2158 / 2490	2178 / 2491
LeSabre (not sw)	65-84	-4116-	C-R	ND	6010												2158 / 2490	2178 / 2491
Luxus (rwd only)	73-87	4114	C-R	ND	6008												2158 / 2490	2178 / 2491
Park Avenue	97-05	4105	C-R	ND	6013												2158 / 2490	2178 / 2491
Park Avenue (not sw)	85-96	4107	C-R	ND	6021												2158 / 2490	2178 / 2491
Regal (rwd only)	73-87	4114	C-R	ND	6008												2158 / 2490	2178 / 2491
Riviera	95-98	4105	C-R	ND	6013												2158 / 2490	2178 / 2491
Riviera	79-85	4106	C-R	ND	6015												2158 / 2490	2178 / 2491
Roadmaster, Roadmaster Estate Wagon	91-96	-4116-	C-R	ND	6010												2158 / 2490	2178 / 2491
Skyhawk	82-89	4104	C-R	ND	6012												2158 / 2490	2178 / 2491
Skylark	85-96	4104	C-R	ND	6012												2158 / 2490	2178 / 2491
Skylark	80-84	4103	C-R	ND	6014												2158 / 2490	2178 / 2491
Somerset	85-87	4104	C-R	ND	6012												2158 / 2490	2178 / 2491
Special, Deluxe, Grand Sport, Skylark (not sw)	67-72	-4113-	C-R	ND	6007												2158 / 2490	2178 / 2491
Wildcat	65-69	-4116-	C-R	ND	6010												2158 / 2490	2178 / 2491
Buick Van																		
Terraza	05-07	4155	C-R	ND	6020												2158 / 2490	2178 / 2491
Cadillac Cars																		
All Rear Drive Models	65-93	-4116-	C-R	ND	6010												2158 / 2490	2178 / 2491
CTS, STS	06-10	4168	C-R	ND	6027												2158 / 2490	2178 / 2491
Coupe Deville, Fleetwood, Sedan Deville, Touring Sedan (fwd only)	85-93	4107	C-R	ND	6021												2158 / 2490	2178 / 2491
El Dorado	79-85	4106	C-R	ND	6015												2158 / 2490	2178 / 2491
Seville	80-85	4106	C-R	ND	6015												2158 / 2490	2178 / 2491
Cadillac SUVs																		
Escalade, ESV, EXT (4X2, 4X4)	11	4186	C-R	ND	6015								8628	ND			2158 / 2490	2178 / 2491

SEE PAGE 54 FOR ADDITIONAL LIFTED/LOWERED VEHICLE APPLICATIONS & SPACERS

 ND= No Drill	A.C.=Air Conversion	R-R=Ride-Rite
sw= Station Wagon	C-R=Coil-Rite	W-R=Work-Rite
fwd= Front Wheel Drive	L-R=Level-Rite	
rwd= Rear Wheel Drive	S-R=Sport-Rite	

Minimum Tire to Frame Clearance Requirements: * = 7.50" ** = 3.00" *** = 9.50" + = 8.00" ++ = 6.00" +++ = 6.50"
 -0000- While Supplies Last # = Use spacer kit 2366 with heavy duty package
 DO NOT EXCEED THE VEHICLE'S RECOMMENDED GROSS VEHICLE WEIGHT RATING (GVWR)

MODEL	YEAR	Air Leveling Rear				Air Leveling Front				Work-Rite			Shocks		Recommended Air Accessory Systems		
		REAR KIT	TYPE		SPRING ONLY	FRONT KIT	TYPE		SPRING ONLY	FRONT KIT		REAR KIT		FRONT	REAR	SINGLE	DUAL
Cadillac SUVs Continued																	
Escalade, ESV, EXT (4X2, 4X4)	02-10	4108	C-R	ND	6003							8628	ND			2158 / 2490	2178 / 2491
Escalade (4X2, 4X4) (4 door only)	99-00	2101	R-R	ND	6781											2158 / 2490	2178 / 2491
Chevrolet Cars																	
Aveo	10	4103	C-R	ND	6014											2158 / 2490	2178 / 2491
Beretta, Corsica	88-96	4104	C-R	ND	6012											2158 / 2490	2178 / 2491
Camaro, Z-28, IROC-Z	82-02	4103	C-R	ND	6014											2158 / 2490	2178 / 2491
Caprice (not sw)	71-96	-4116-	C-R	ND	6010											2158 / 2490	2178 / 2491
Caprice (sw only)	77-96	-4116-	C-R	ND	6010											2158 / 2490	2178 / 2491
Cavalier	82-94	4104	C-R	ND	6012											2158 / 2490	2178 / 2491
Celebrity	82-90	4103	C-R	ND	6014											2158 / 2490	2178 / 2491
Chevelle	73-83	4114	C-R	ND	6008											2158 / 2490	2178 / 2491
Chevelle	67-72	-4113-	C-R	ND	6007											2158 / 2490	2178 / 2491
El Camino	67-87	4114	C-R	ND	6008											2158 / 2490	2178 / 2491
Impala (not sw)	71-96	-4116-	C-R	ND	6010											2158 / 2490	2178 / 2491
Impala (sw only)	77-96	-4116-	C-R	ND	6010											2158 / 2490	2178 / 2491
Laguna	73-83	4114	C-R	ND	6008											2158 / 2490	2178 / 2491
Malibu	73-83	4114	C-R	ND	6008											2158 / 2490	2178 / 2491
Malibu	67-72	-4113-	C-R	ND	6007											2158 / 2490	2178 / 2491
Monte Carlo SS (only)	84-88	-4113-	C-R	ND	6007											2158 / 2490	2178 / 2491
Monte Carlo (not SS)	73-88	4114	C-R	ND	6008											2158 / 2490	2178 / 2491
Monte Carlo	67-72	-4113-	C-R	ND	6007											2158 / 2490	2178 / 2491
Chevrolet/GMC Vans																	
Astro, Safari (4x2, 4x4)	99-05	2361	R-R	ND	6397											2158 / 2490	2178 / 2491
Astro, Safari (4x2, 4x4) (cargo van only, not passenger van, continuously loaded vehicles only)	85-98	-2029-	R-R		6859											2158 / 2490	2178 / 2491
G-1500 (6 lug nuts, GVWR 7200)	03-09	2423	R-R		6868											2158 / 2490	2178 / 2491
G-1500, G-2500 (6 lug nuts)	96-02	2163 +++	S-R		9001											2158 / 2490	2178 / 2491
G-10, G-20, G-30, G-1500, G-2500, G-3500	70-95	0830	R-R		6859	4100	C-R	ND	6000							2158 / 2490	2178 / 2491
G-2500 G-3500 (8 lug nuts) (Over 8600 GVW) (single rear wheel)	03-10	2337	S-R		9000											2158 / 2490	2178 / 2491
G-2500 G-3500 (8 lug nuts) (Over 8600 GVW) (single rear wheel)	96-02	-2185-	S-R		9000											2158 / 2490	2178 / 2491
Lumina APV	90-96	-4110-	C-R	ND	6015											2158 / 2490	2178 / 2491
Uplander	05-09	4155	C-R	ND	6020											2158 / 2490	2178 / 2491
Chevrolet/GMC SUVs																	
Avalanche 1500 (4x2, 4x4)	11	4186	C-R	ND	6015							8628	ND			2158 / 2490	2178 / 2491
Avalanche 1500 (4x2, 4x4)	02-10	4108	C-R	ND	6003							8628	ND			2158 / 2490	2178 / 2491
Blazer (4x2 only) (full size)	73-91					4100	C-R	ND	6000							2158 / 2490	2178 / 2491
Blazer (4x4 only) (full size)	73-91					-2119-	R-R	ND	6762							2158 / 2490	2178 / 2491
Denali XL 2500 (4x2, 4x4)	00-09	2253	R-R		6781	1003	L-R	ND	7210							2158 / 2490	2178 / 2491
Envoy (4x2, 4x4) (with rear coil springs)	02-09	4108	C-R	ND	6003											2158 / 2490	2178 / 2491

SEE PAGE 54 FOR ADDITIONAL LIFTED/LOWERED VEHICLE APPLICATIONS & SPACERS

 ND= No Drill A.C.=Air Conversion R-R=Ride-Rite
 sw= Station Wagon C-R=Coil-Rite W-R=Work-Rite
 fwd= Front Wheel Drive L-R=Level-Rite
 rwd= Rear Wheel Drive S-R=Sport-Rite

Minimum Tire to Frame Clearance Requirements: * = 7.50" ** = 3.00" *** = 9.50" + = 8.00" ++ = 6.00" +++ = 6.50"
 -0000- While Supplies Last # = Use spacer kit 2366 with heavy duty package
 DO NOT EXCEED THE VEHICLE'S RECOMMENDED GROSS VEHICLE WEIGHT RATING (GVWR)

MODEL	YEAR	Air Leveling Rear				Air Leveling Front				Work-Rite			Shocks		Recommended Air Accessory Systems		
		REAR KIT	TYPE	⊖	SPRING ONLY	FRONT KIT	TYPE	⊖	SPRING ONLY	FRONT KIT	⊖	REAR KIT	⊖	FRONT	REAR	SINGLE	DUAL
Chevrolet/GMC SUVs Continued																	
Equinox (4x2, 4x4)	05-06	-4167-	C-R	ND	6027											2158 / 2490	2178 / 2491
Jimmy (4x2 only) (full size)	73-91								4100	C-R	ND	6000				2158 / 2490	2178 / 2491
Jimmy (4x4 only) (full size)	73-91								-2119-	R-R	ND	6762				2158 / 2490	2178 / 2491
Suburban 1500 (4x2, 4x4)	11	4186	C-R	ND	6015								8628	ND		2158 / 2490	2178 / 2491
Suburban 1500 (4x2, 4x4)	00-10	4108	C-R	ND	6003								8628	ND		2158 / 2490	2178 / 2491
Suburban 1500 (4x2, 4x4)	92-99	2101	R-R		6781											2158 / 2490	2178 / 2491
Suburban 1500 (4x2 only)	73-91	2100	R-R		6781				4100	C-R	ND	6000				2158 / 2490	2178 / 2491
Suburban 1500 (4x4 only)	73-91	2100	R-R		6781				-2119-	R-R	ND	6762				2158 / 2490	2178 / 2491
Suburban 2500 (4x2, 4x4)	00-09	2253	R-R		6781				1003	L-R	ND	7210	8629	ND		2158 / 2490	2178 / 2491
Suburban 2500 (4x2, 4x4)	92-99	2101	R-R		6781											2158 / 2490	2178 / 2491
Suburban 2500 (4x2 only)	73-91	2100	R-R		6781				4100	C-R	ND	6000				2158 / 2490	2178 / 2491
Suburban 2500 (4x4 only)	73-91	2100	R-R		6781				-2119-	R-R	ND	6762				2158 / 2490	2178 / 2491
Tahoe (4x2, 4x4)	11	4186	C-R	ND	6015								8628	ND		2158 / 2490	2178 / 2491
Tahoe (4x2, 4x4)	00-10	4108	C-R	ND	6003								8628	ND		2158 / 2490	2178 / 2491
Tahoe (4x2, 4x4) (4-door only)	95-99	2101	R-R		6781											2158 / 2490	2178 / 2491
Police Tahoe (4x2, 4x4)	07-10	4147	C-R	ND	6024											2158 / 2490	2178 / 2491
Trailblazer (4x2, 4x4)	02-09	4108	C-R	ND	6003											2158 / 2490	2178 / 2491
Yukon 1500 (4x2, 4x4)	11	4186	C-R	ND	6015								8628	ND		2158 / 2490	2178 / 2491
Yukon 1500 (4x2, 4x4)	00-10	4108	C-R	ND	6003								8628	ND		2158 / 2490	2178 / 2491
Yukon 1500 (4x2, 4x4) (4-door only)	95-99	2101	R-R		6781											2158 / 2490	2178 / 2491
Yukon 1500 (4x2, 4x4) (2-door only)	92-98	2173	R-R	ND	6762											2158 / 2490	2178 / 2491
Yukon XL 2500 (4x2, 4x4)	00-09	2253	R-R		6781				1003	L-R	ND	7210	8629	ND		2158 / 2490	2178 / 2491
Yukon 2500 (4x2, 4x4) (4-door only)	95-99	2101	R-R		6781											2158 / 2490	2178 / 2491
Chevrolet/GMC Pickup Trucks																	
S-10 Crew Cab (4x2 only)	04	2209	S-R		9001											2158 / 2490	2178 / 2491
S-10, Sonoma (4x2 only) (not factory lowered ZQ8)	82-03	2209	S-R		9001											2158 / 2490	2178 / 2491
Colorado, Canyon (4x2, 4x4) (not factory lowered ZQ8)	04-10	2384	R-R	ND	6397											2158 / 2490	2178 / 2491
Silverado, Sierra 1500 (4x2, 4x4)	07-11	2430	R-R	ND	6397								8605	ND		2158 / 2490	2178 / 2491
Silverado Classic, Sierra Classic 1500 (4x2, 4x4)	07	2320 ++	S-R		9000								8605	ND		2158 / 2490	2178 / 2491
Silverado, Sierra 1500 (4x2 only) (not HD)	99-06	2320 ++	S-R		9000							8629	ND	8605	ND	2158 / 2490	2178 / 2491
Silverado, Sierra 1500 (4x4 only) (not HD)	99-06	2320 ++	S-R		9000								8605	ND		2158 / 2490	2178 / 2491
Silverado, Sierra 1500HD (4x2, 4x4) (not Quad-Steer)	05-06	2190	R-R		6781				1003	L-R	ND	7210	8629	ND	8625	2158 / 2490	2178 / 2491
Silverado, Sierra 1500HD (4x2, 4x4) (not Quad-Steer)	01-03	2190	R-R		6781				1003	L-R	ND	7210	8629	ND	8625	2158 / 2490	2178 / 2491
C & K-1500 (4x2, 4x4)	88-98	2025	R-R		6781								8622			2158 / 2490	2178 / 2491
C & K-1500 (4x2 only)	88-98	2162 +++	S-R		9002											2158 / 2490	2178 / 2491
C & R 10, 1500 (4x2 only)	73-87	2071 *	R-R		6781				4100	C-R	ND	6000				2158 / 2490	2178 / 2491
K & V-10, 1500 (4x4 only)	73-87	2040 ***	R-R		6873				-2119-	R-R	ND	6762				2158 / 2490	2178 / 2491
Silverado, Sierra C2500 (4x2 only) (not HD)	99-05	2190	R-R		6781				1003	L-R	ND	7210		8625		2158 / 2490	2178 / 2491

SEE PAGE 54 FOR ADDITIONAL LIFTED/LOWERED VEHICLE APPLICATIONS & SPACERS

⊖ ND= No Drill A.C.=Air Conversion R-R=Ride-Rite
 sw= Station Wagon C-R=Coil-Rite W-R=Work-Rite
 fwd= Front Wheel Drive L-R=Level-Rite
 rwd= Rear Wheel Drive S-R=Sport-Rite





Minimum Tire to Frame Clearance Requirements: * = 7.50" ** = 3.00" *** = 9.50" + = 8.00" ++ = 6.00" +++ = 6.50"
 -0000- While Supplies Last # = Use spacer kit 2366 with heavy duty package
 DO NOT EXCEED THE VEHICLE'S RECOMMENDED GROSS VEHICLE WEIGHT RATING (GVWR)

MODEL	YEAR	Air Leveling Rear					Air Leveling Front				Work-Rite			Shocks		Recommended Air Accessory Systems	
		REAR KIT	TYPE	⊕	SPRING ONLY		FRONT KIT	TYPE	⊕	SPRING ONLY	FRONT KIT	⊕	REAR KIT	⊕	FRONT	REAR	SINGLE
Chevrolet/GMC Pickup Trucks Continued																	
Silverado, Sierra C2500 (4x2 only) (not HD)	99-05	2190	R-R		6781		1003	L-R	ND	7210	8629	ND	8625			2158 / 2490	2178 / 2491
Silverado, Serra 2500HD (4x2, 4x4) Available 1/11	11	2528	R-R		6401						8635	ND	8631	ND		2097 / 2490	2219 / 2491
Silverado, Sierra 2500HD (4x2 only)	01-10	2250	R-R	ND	6781		1003	L-R	ND	7210	8629	ND	8602	ND	4353	2097 / 2490	2219 / 2491
Silverado, Sierra 2500HD (4x4 only)	01-10	2250	R-R	ND	6781		1003	L-R	ND	7210	8629	ND	8604	ND	4353	2097 / 2490	2219 / 2491
C & K-2500 (4x2, 4x4) (with rear drum brakes)	99-00	2025	R-R		6781								8623			2097 / 2490	2219 / 2491
C & K-2500 (4x2, 4x4)	88-98	2025	R-R		6781								8623			2097 / 2490	2219 / 2491
C & R-20 (4x2 only)	73-87	2071 *	R-R		6781		4100	C-R	ND	6000						2097 / 2490	2219 / 2491
K & V-20, 2500 (4x4 only)	73-87	2040 ***	R-R		6873		-2119-	R-R	ND	6762						2097 / 2490	2219 / 2491
Silverado, Serra 3500HD (4x2, 4x4) Available 1/11	11	2528	R-R		6401						8635	ND	8632	ND		2097 / 2490	2219 / 2491
Silverado, Sierra 3500HD (4x2, only)	01-10	2250	R-R	ND	6781		1003	L-R	ND	7210	8629	ND	8609	ND	4355	2097 / 2490	2219 / 2491
Silverado, Sierra 3500HD (4x4 only)	01-10	2250	R-R	ND	6781		1003	L-R	ND	7210	8629	ND	8610	ND	4355	2097 / 2490	2219 / 2491
C & K-3500 (4x2, 4x4)	88-00	2025	R-R		6781								8624			2097 / 2490	2219 / 2491
C & R-30, C & R-3500 (4x2 only)	73-87	2071 *	R-R		6781											2097 / 2490	2219 / 2491
C-30 (4X2 only)	67-87	2071 *	R-R		6781		4100	C-R	ND	6000						2097 / 2490	2219 / 2491
K & V-30, 3500 (4x4 only)	73-87	2040 ***	R-R		6873		-2119-	R-R	ND	6762						2097 / 2490	2219 / 2491
Chevrolet/GMC Commercial Vehicles (vehicles without factory bed)																	
C3500HD (4x2, 4x4)	11	2176	R-R		6781						8635	ND				2097 / 2490	2219 / 2491
C-2500 HD, C-3500 HD (4x2, 4x4)	01-10	2249	R-R	ND	6781		1003	L-R	ND	7210	8629	ND	8617	ND		2097 / 2490	2219 / 2491
C-3500 (Type I ambulance chassis)	88-00	-2065-***	R-R		0335											2097 / 2490	2219 / 2491
C-4500, C-5500 (4x2 only)	02-09	2362 *	R-R		6781		2451	R-R	ND	6401						2097 / 2490	2219 / 2491
G-4500 (with dual rear wheels)	08-11	2173	R-R	ND	6762								8619	ND		2097 / 2490	2219 / 2491
G-3500 (with dual rear wheels)	98-11	2173	R-R	ND	6762								8619	ND		2097 / 2490	2219 / 2491
G-30, G-3500	70-95	0830	R-R		6859		4100	C-R	ND	6000						2097 / 2490	2219 / 2491
W-3500	96-09	2449	S-R		9001		2440	R-R		6868						2097 / 2490	2219 / 2491
Chevrolet/GMC Motorhomes Class "C" Vans																	
G-3500, G-4500 (with dual rear wheels)	98-11	2173	R-R	ND	6762											2097 / 2490	2219 / 2491
G-30, G-3500	70-95	0830	R-R		6859		4100	C-R	ND	6000						2097 / 2490	2219 / 2491
Chevrolet/GMC Motorhomes Class "A" & Step Vans																	
GP-30 HD (cutaway) (10,500 to 12,300 GVWR)	93-96	2080	R-R	ND	6859		4100	C-R	ND	6000						2097 / 2490	2219 / 2491
GP-30 HD (cutaway) (14,500 GVWR)	93-96	2085	R-R	ND	0335		4100	C-R	ND	6000						2097 / 2490	2219 / 2491
P-30 (10,500 to 12,800 GVWR) (with jounce bumpers mounted at bottom of frame rails)	93-96	2080	R-R	ND	6859		4100	C-R	ND	6000						2097 / 2490	2219 / 2491
P-30 (14,500 to 16,000 GVWR)	93-99	2147 *	R-R		6781		4100	C-R	ND	6000						2097 / 2490	2219 / 2491
P-30 (14,500 to 17,000 GVWR) (with jounce bumper mounted above leaf springs)	93-99	2085	R-R	ND	0335		4100	C-R	ND	6000						2097 / 2490	2219 / 2491
P-30 (with jounce bumpers mounted at bottom of frame rails)	63-92	2080	R-R	ND	6859		4100	C-R	ND	6000						2097 / 2490	2219 / 2491
Chrysler Cars																	
Imperial, New Yorker 5th Ave. Landau and Salon	90-94	4105	C-R	ND	6013											2158 / 2490	2178 / 2491
Le Baron, GTS, TC By Maserati	82-95	4105	C-R	ND	6013											2158 / 2490	2178 / 2491

SEE PAGE 54 FOR ADDITIONAL LIFTED/LOWERED VEHICLE APPLICATIONS & SPACERS

⊕ ND= No Drill A.C.=Air Conversion R-R=Ride-Rite
 sw= Station Wagon C-R=Coil-Rite W-R=Work-Rite
 fwd= Front Wheel Drive L-R=Level-Rite
 rwd= Rear Wheel Drive S-R=Sport-Rite





Minimum Tire to Frame Clearance Requirements: * = 7.50" ** = 3.00" *** = 9.50" + = 8.00" ++ = 6.00" +++ = 6.50"
 -0000- While Supplies Last # = Use spacer kit 2366 with heavy duty package
 DO NOT EXCEED THE VEHICLE'S RECOMMENDED GROSS VEHICLE WEIGHT RATING (GVWR)

MODEL	YEAR	Air Leveling Rear				Air Leveling Front				Work-Rite			Shocks		Recommended Air Accessory Systems		
		REAR KIT	TYPE		SPRING ONLY	FRONT KIT	TYPE		SPRING ONLY	FRONT KIT		REAR KIT		FRONT	REAR	SINGLE	DUAL
Chrysler Cars Continued																	
New Yorker	84-89	4105	C-R	ND	6013											2158 / 2490	2178 / 2491
PT Cruiser, PT Cruiser Classic	01-10	-4139-	C-R	ND	6015											2158 / 2490	2178 / 2491
Town and Country (sw only)	84-89	4105	C-R	ND	6013											2158 / 2490	2178 / 2491
Chrysler Van																	
Town and Country	08-11	4169	C-R		6013											2158 / 2490	2178 / 2491
Town and Country	96-07	1005	L-R	ND	7217						8627	ND				2158 / 2490	2178 / 2491
Chrysler SUV																	
Aspen (4x2, 4x4)	07-09	4152	C-R	ND	6009											2158 / 2490	2178 / 2491
Dodge Cars																	
400, 600, Lancer, Daytona	82-94	4105	C-R	ND	6013											2158 / 2490	2178 / 2491
Aries	81-89	4105	C-R	ND	6013											2158 / 2490	2178 / 2491
Dynasty, Spirit	90-94	4105	C-R	ND	6013											2158 / 2490	2178 / 2491
Shadow	87-94	4105	C-R	ND	6013											2158 / 2490	2178 / 2491
Dodge Vans																	
Caravan, Grand Caravan	08-11	4169	C-R		6013											2158 / 2490	2178 / 2491
Caravan, Grand Caravan	96-07	1005	L-R	ND	7217						8627	ND				2158 / 2490	2178 / 2491
Sprinter 2500	03-06	2312 +++	S-R		9002											2158 / 2490	2178 / 2491
Sprinter 3500	03-06	2425	R-R		6781											2158 / 2490	2178 / 2491
B100, B150, B200, B250, B300, B350, 1500, 2500, 3500, MB300, MB400	77-03	2109	R-R	ND	6781											2158 / 2490	2178 / 2491
B100, B200, B300	71-76	0830	R-R		6859											2158 / 2490	2178 / 2491
Dodge SUVs																	
Nitro (4x2, 4x4)	07-08	4146	C-R		6005											2158 / 2490	2178 / 2491
Durango (4x2, 4x4)	04-09	4152	C-R	ND	6009											2158 / 2490	2178 / 2491
Durango (4x2, 4x4) (not SXT)	97-02	2222	S-R	ND	9002											2158 / 2490	2178 / 2491
Dodge/Ram Pickup Trucks																	
Ram 50	80-93	1130 **	R-R	ND	6873											2158 / 2490	2178 / 2491
Dakota Club Cab (4x2, 4x4)	05-10	2378 +++	S-R		9000											2158 / 2490	2178 / 2491
Dakota Quad Cab (4x2, 4x4)	05-10	2379 +++	S-R		9000											2158 / 2490	2178 / 2491
Dakota Standard & Crew Cab (4x2 only)	97-02	2169 +++	S-R		9000											2158 / 2490	2178 / 2491
Dakota (4x4 only) (not crew cab)	97-03	2162 +++	S-R		9002											2158 / 2490	2178 / 2491
Dakota Crew Cab (4x4 only)	00-03	2217 +++	S-R		9000											2158 / 2490	2178 / 2491
Ram 1500 (4x2, 4x4) (Available 1/2011)	09-11	2518	A.C.	ND	9047											N/A	N/A
Ram 1500 (4x2, 4x4)	09-11	4190	C-R	ND	6030											2158 / 2490	2178 / 2491
Ram 1500 (4x2, 4x4)	09-11	-4185-	C-R	ND	6025								-8620-	ND		2158 / 2490	2178 / 2491
Ram 1500 (4x2 only)	02-08	2286	R-R	ND	6781								8607	ND		2158 / 2490	2178 / 2491
Ram 1500 (4x4 only)	02-08	2286	R-R	ND	6781								8603	ND		2158 / 2490	2178 / 2491
Ram 1500 Mega Cab (4x2 only)	06-08	2299	R-R	ND	6401											2158 / 2490	2178 / 2491
Ram 1500 Mega Cab (4x4 only)	06-08	2299	R-R	ND	6401					8621	ND					2158 / 2490	2178 / 2491

SEE PAGE 54 FOR ADDITIONAL LIFTED/LOWERED VEHICLE APPLICATIONS & SPACERS

 ND= No Drill
 sw= Station Wagon
 fwd= Front Wheel Drive
 rwd= Rear Wheel Drive
 A.C.=Air Conversion
 C-R=Coil-Rite
 L-R=Level-Rite
 S-R=Sport-Rite
 R-R=Ride-Rite
 W-R=Work-Rite





Minimum Tire to Frame Clearance Requirements: * = 7.50" ** = 3.00" *** = 9.50" + = 8.00" ++ = 6.00" +++ = 6.50"
 -0000- While Supplies Last # = Use spacer kit 2366 with heavy duty package
 DO NOT EXCEED THE VEHICLE'S RECOMMENDED GROSS VEHICLE WEIGHT RATING (GVWR)

MODEL	YEAR	Air Leveling Rear					Air Leveling Front				Work-Rite			Shocks		Recommended Air Accessory Systems		
		REAR KIT	TYPE		SPRING ONLY		FRONT KIT	TYPE		SPRING ONLY	FRONT KIT		REAR KIT		FRONT	REAR	SINGLE	DUAL
Dodge/Ram Pickup Trucks Continued																		
Ram 1500 (4x2 only)	94-01	2071 *	R-R		6781		4111	C-R	ND	6015							2158 / 2490	2178 / 2491
Ram 1500 (4x2 only)	94-01	2162 +++	R-R		9002		4111	C-R	ND	6015							2158 / 2490	2178 / 2491
Ram 1500 (4x4 only)	94-01	2071 *	R-R		6781						8621	ND					2158 / 2490	2178 / 2491
D & W 100, 150, Ram 1500 (4x2, 4x4)	69-93	2071 *	R-R		6781												2158 / 2490	2178 / 2491
Ram 2500 (4x2 only) (not power wagon for LS product)	03-11	2299	R-R	ND	6401							8608	ND		4350		2097 / 2490	2219 / 2491
Ram 2500 (4x4 only) (not power wagon for LS product)	03-11	2299	R-R	ND	6401		1004	L-R	ND	7215	8621	ND	8608	ND	4350		2097 / 2490	2219 / 2491
Ram 2500 (4x2 only)	94-02	2071 *	R-R		6781		4111	C-R	ND	6015							2097 / 2490	2219 / 2491
Ram 2500 (4x4 only)	94-02	2071 *	R-R		6781						8621	ND					2097 / 2490	2219 / 2491
D & W 200, 250, Ram 2500 (4x2, 4x4)	69-93	2071 *	R-R		6781												2097 / 2490	2219 / 2491
Ram 2500 (4x2, 4x4) (with contact overload springs)	94-98	2220	R-R	ND	6781												2097 / 2490	2219 / 2491
Ram 3500 (4x2 only)	07-11	2299	R-R	ND	6401						8621	ND	8611	ND	4350		2097 / 2490	2219 / 2491
Ram 3500 (4x2 only)	03-06	2299	R-R	ND	6401								8611	ND	4350		2097 / 2490	2219 / 2491
Ram 3500 (4x4 only)	03-11	2299	R-R	ND	6401		1004	L-R	ND	7215	8621	ND	8611	ND	4350		2097 / 2490	2219 / 2491
Ram 3500 (4x2 only)	94-02	2071 *	R-R		6781		4111	C-R	ND	6015							2097 / 2490	2219 / 2491
Ram 3500 (4x4 only)	94-02	2071 *	R-R		6781						8621	ND					2097 / 2490	2219 / 2491
D & W 300, 350, Ram 3500 (4x2, 4x4)	69-93	2071 *	R-R		6781												2097 / 2490	2219 / 2491
Dodge/Ram Commercial Vehicles (vehicles without factory bed)																		
Ram 2500, 3500 (4x2, 4x4) (not dually)	04-08	2299	R-R	ND	6401												2097 / 2490	2219 / 2491
Ram 3500 (4x4 only) (dually only)	06-08	2299	R-R	ND	6401												2097 / 2490	2219 / 2491
Ram 3500 HD (4x2, 4x4) (cab & chassis)	07-11	2478 +	R-R		6781							8611	ND				2097 / 2490	2219 / 2491
D3500, W3500 (4x2, 4x4) (cab & chassis)	94-02	2220	R-R	ND	6781							8611	ND				2097 / 2490	2219 / 2491
RAM 4500, 5500 (4x2, 4x4) (requires 2" clearance above frame)	07-11	2404 ***	R-R		7325												2097 / 2490	2219 / 2491
Sprinter 2500 (cab & chassis)	02-06	2312 +++	S-R		9002												2097 / 2490	2219 / 2491
Sprinter 3500 (van and cab & chassis)	02-06	2425	R-R		6781												2097 / 2490	2219 / 2491
Sprinter 3500 (cab & chassis)	02-06	2382	R-R		6781												2097 / 2490	2219 / 2491
Dodge Motorhomes Class "C" Vans																		
Sprinter 2500 (van and cab & chassis)	03-06	2312 +++	S-R	ND	9002												2097 / 2490	2219 / 2491
Sprinter 3500 (van and cab & chassis)	03-06	2425	R-R		6781												2097 / 2490	2219 / 2491
Sprinter 3500 (cab & chassis)	03-06	2382	R-R		6781												2097 / 2490	2219 / 2491
B100, B150, B200, B250, B300, B350, 1500, 2500, 3500, MB300, MB400	77-03	2109	R-R	ND	6781												2097 / 2490	2219 / 2491
B100, B200, B300	71-76	0830	R-R		6859												2097 / 2490	2219 / 2491
Ford Cars																		
Country Squire	83-97	4108	C-R	ND	6003												2158 / 2490	2178 / 2491
Crown Victoria (with rear coil springs)	98-08	4107	C-R	ND	6021												2158 / 2490	2178 / 2491
Crown Victoria	83-97	4108	C-R	ND	6003												2158 / 2490	2178 / 2491
Fusion	06-11	4169	C-R		6013												2158 / 2490	2178 / 2491

SEE PAGE 54 FOR ADDITIONAL LIFTED/LOWERED VEHICLE APPLICATIONS & SPACERS

 ND= No Drill A.C.=Air Conversion R-R=Ride-Rite
 sw= Station Wagon C-R=Coil-Rite W-R=Work-Rite
 fwd= Front Wheel Drive L-R=Level-Rite
 rwd= Rear Wheel Drive S-R=Sport-Rite





Minimum Tire to Frame Clearance Requirements: * = 7.50" ** = 3.00" *** = 9.50" + = 8.00" ++ = 6.00" +++ = 6.50"
 -0000- While Supplies Last # = Use spacer kit 2366 with heavy duty package
 DO NOT EXCEED THE VEHICLE'S RECOMMENDED GROSS VEHICLE WEIGHT RATING (GVWR)

MODEL	YEAR	Air Leveling Rear				Air Leveling Front				Work-Rite			Shocks		Recommended Air Accessory Systems		
		REAR KIT	TYPE		SPRING ONLY	FRONT KIT	TYPE		SPRING ONLY	FRONT KIT		REAR KIT		FRONT	REAR	SINGLE	DUAL
Ford Cars Continued																	
LTD	83-86	4103	C-R	ND	6014											2158 / 2490	2178 / 2491
Mustang	79-03	4103	C-R	ND	6014											2158 / 2490	2178 / 2491
Taurus (sw only)	99-06	-4141-	C-R	ND	6005											2158 / 2490	2178 / 2491
Taurus (sw only)	86-98	4105	C-R	ND	6013											2158 / 2490	2178 / 2491
Thunderbird	92-97	4105	C-R	ND	6013											2158 / 2490	2178 / 2491
Thunderbird	89-91	4104	C-R	ND	6012											2158 / 2490	2178 / 2491
Thunderbird	80-88	4106	C-R	ND	6015											2158 / 2490	2178 / 2491
Ford Vans																	
Transit Connect	10-11	2485	R-R	ND	6762							8634	ND			2158 / 2490	2178 / 2491
Freestar	04-07	4151	C-R	ND	6016											2158 / 2490	2178 / 2491
Windstar	98-03	4106	C-R	ND	6015											2158 / 2490	2178 / 2491
E-150	08-11	2488	R-R	ND	6764	4101	C-R	ND	6002							2158 / 2490	2178 / 2491
E-150	75-07	2171	S-R		7076	4101	C-R	ND	6002							2158 / 2490	2178 / 2491
E-100, E-150 (may require tailpipe modification)	75-91	2032	R-R	ND	6859	4101	C-R	ND	6002							2158 / 2490	2178 / 2491
E-250	98-11	2165	S-R		9002	4101	C-R	ND	6002							2158 / 2490	2178 / 2491
E-250 (may require tailpipe modification)	75-91	2032	R-R	ND	6859	4101	C-R	ND	6002							2158 / 2490	2178 / 2491
E-350 (with single rear wheels)	98-11	2181	S-R		9000	4101	C-R	ND	6002							2158 / 2490	2178 / 2491
E-350 (may require tailpipe modification)	75-91	2032	R-R	ND	6859	4101	C-R	ND	6002							2158 / 2490	2178 / 2491
Ford CUV																	
Edge	07-10	4171	C-R	ND	6020											2158 / 2490	2178 / 2491
Flex	09-11	4177	C-R	ND	6015											2158 / 2490	2178 / 2491
Ford SUVs																	
Bronco (4x4) (full size)	90-96	2071 *	R-R		6781	4102	C-R	ND	6011							2158 / 2490	2178 / 2491
Bronco (4x2, 4x4)	80-90					4102	C-R	ND	6011							2158 / 2490	2178 / 2491
Expedition (4x2, 4x4) (with rear coil springs)	97-02	4134	C-R	ND	6022											2158 / 2490	2178 / 2491
Excursion (4x2 only)	00-06	2255	R-R	ND	6781											2158 / 2490	2178 / 2491
Excursion (4x4 only)	00-06	2251	R-R	ND	6781											2158 / 2490	2178 / 2491
Ford Pickup Trucks (without in bed hitch)																	
Ranger (4x2, 4x4) (not SuperCab 4x4 with 6' bed)	10-11	2531 +++	S-R		9000											2158 / 2490	2178 / 2491
Ranger (4x2, 4x4) (not for use with composite leaf) (not SuperCab 4x4 with 6' bed)	83-09	2172 +++	S-R		9001											2158 / 2490	2178 / 2491
F-100 (4x2, 4x4)	68-79	2071 *	R-R		6781	4102	C-R	ND	6011							2158 / 2490	2178 / 2491
F-150 (4x2, 4x4) (not Raptor)	09-11	2525 +	R-R	ND	6781							8606	ND			2158 / 2490	2178 / 2491
F-150 (4x2, 4x4) (not FX2)	04-08	2350 #	R-R	ND	6397							8606	ND			2158 / 2490	2178 / 2491
F-150 Heritage (4x2, 4x4)	04	2320 ++	S-R		9000											2158 / 2490	2178 / 2491
F-150 (4x2, 4x4)	97-03	2320 ++	S-R		9000											2158 / 2490	2178 / 2491
F-150 (4x2, 4x4)	68-96	2071 *	R-R		6781	4102	C-R	ND	6011							2158 / 2490	2178 / 2491
F-250 Under 8500 GVWR (4x2, 4x4)	97-03	2320 ++	S-R		9000											2158 / 2490	2178 / 2491

SEE PAGE 54 FOR ADDITIONAL LIFTED/LOWERED VEHICLE APPLICATIONS & SPACERS

 ND= No Drill A.C.=Air Conversion R-R=Ride-Rite
 sw= Station Wagon C-R=Coil-Rite W-R=Work-Rite
 fwd= Front Wheel Drive L-R=Level-Rite
 rwd= Rear Wheel Drive S-R=Sport-Rite





Minimum Tire to Frame Clearance Requirements: * = 7.50" ** = 3.00" *** = 9.50" + = 8.00" ++ = 6.00" +++ = 6.50"
 -0000- While Supplies Last # = Use spacer kit 2366 with heavy duty package
 DO NOT EXCEED THE VEHICLE'S RECOMMENDED GROSS VEHICLE WEIGHT RATING (GVWR)

MODEL	YEAR	Air Leveling Rear					Air Leveling Front				Work-Rite			Shocks		Recommended Air Accessory Systems	
		REAR KIT	TYPE		SPRING ONLY		FRONT KIT	TYPE		SPRING ONLY	FRONT KIT		REAR KIT		FRONT	REAR	SINGLE
Ford Pickup Trucks (without in bed hitch) Continued																	
F-250 Under 8500 GVWR (4x2 only)	69-96	2071 *	R-R		6781		4101	C-R	ND	6002						2158 / 2490	2178 / 2491
F-250 Under 8500 GVWR (4x4 only)	69-96	2071 *	R-R		6781											2158 / 2490	2178 / 2491
F-250 (4x2 only)	11						4101	C-R	ND	6002	8616	ND				2097 / 2490	2219 / 2491
Gasoline (rear kits)		2452 *	R-R	ND	6781							8614	ND		4351	2097 / 2490	2219 / 2491
Diesel (rear kits)		2071 *	R-R		6781							8614	ND		4351	2097 / 2490	2219 / 2491
F-250 (4x2 only)	08-10	2452 *	R-R	ND	6781		4101	C-R	ND	6002	8616	ND	8614	ND	4351	2097 / 2490	2219 / 2491
F-250 (4x2 only)	05-07	2071 *	R-R		6781		4101	C-R	ND	6002	8616	ND	8614	ND	4351	2097 / 2490	2219 / 2491
F-250 Over 8500 GVWR (4x2 only)	99-04	2484 *	R-R	ND	6781		4101	C-R	ND	6002			8612	ND	4351	2097 / 2490	2219 / 2491
F-250 Over 8500 GVWR (4x2 only)	84-98	2071 *	R-R		6781		4101	C-R	ND	6002						2097 / 2490	2219 / 2491
F-250 Over 8500 GVWR (4x2 only)	69-83	2071 *	R-R		6781											2097 / 2490	2219 / 2491
F-250 (4x4 only)	11						4160	C-R	ND	6025	8616	ND				2097 / 2490	2219 / 2491
Gasoline (rear kits)		2452 *	R-R	ND	6781							8614	ND		4351	2097 / 2490	2219 / 2491
Diesel (rear kits)		2071 *	R-R		6781							8614	ND		4351	2097 / 2490	2219 / 2491
F-250 (4x4 only)	08-10	2452 *	R-R	ND	6781		4160	C-R	ND	6025	8616	ND	8614	ND	4351	2097 / 2490	2219 / 2491
F-250 (4x4 only)	05-07	2071 *	R-R		6781		4160	C-R	ND	6025	8616	ND	8614	ND	4351	2097 / 2490	2219 / 2491
F-250 Over 8500 GVWR (4x4 only)	99-04	2484 *	R-R		6781		2223	R-R		6762			8612	ND	4351	2097 / 2490	2219 / 2491
F-250 Over 8500 GVWR (4x4 only)	84-04	2071 *	R-R		6781		2223	R-R		6762						2097 / 2490	2219 / 2491
F-250 Over 8500 GVWR (4x4 only)	69-83	2071 *	R-R		6781											2097 / 2490	2219 / 2491
F-350 (4x2 only)	11						4101	C-R	ND	6002	8616	ND				2097 / 2490	2219 / 2491
Gasoline (rear kits)		2452 *	R-R	ND	6781							8614	ND		4351	2097 / 2490	2219 / 2491
Diesel (rear kits)		2071 *	R-R		6781							8614	ND		4351	2097 / 2490	2219 / 2491
F-350 (4x2 only)	08-10	2452 *	R-R	ND	6781		4101	C-R	ND	6002	8616	ND	8615	ND	4351	2097 / 2490	2219 / 2491
F-350 (4x2 only)	06-07	2071 *	R-R		6781		4101	C-R	ND	6002	8616	ND	8615	ND	4351	2097 / 2490	2219 / 2491
F-350 (4x2 only)	05	2071 *	R-R		6781		4160	C-R	ND	6025	8616	ND	8615	ND	4351	2097 / 2490	2219 / 2491
F-350 (4x2 only)	99-04	2484 *	R-R	ND	6781		4101	C-R	ND	6002			8613	ND	4351	2097 / 2490	2219 / 2491
F-350 (4x2 only)	70-98	2071 *	R-R		6781		4101	C-R	ND	6002						2097 / 2490	2219 / 2491
F-350 (4x2 only)	63-69	2071 *	R-R		6781											2097 / 2490	2219 / 2491
F-350 (4x4 only)	11						4160	C-R	ND	6025	8616	ND				2097 / 2490	2219 / 2491
Gasoline (rear kits)		2452 *	R-R	ND	6781							8614	ND		4351	2097 / 2490	2219 / 2491
Diesel (rear kits)		2071 *	R-R		6781							8614	ND		4351	2097 / 2490	2219 / 2491
F-350 (4x4 only)	08-10	2452 *	R-R	ND	6781		4160	C-R	ND	6025	8616	ND	8615	ND	4354	2097 / 2490	2219 / 2491
F-350 (4x4 only)	06-07	2071 *	R-R		6781		4160	C-R	ND	6025	8616	ND	8615	ND	4354	2097 / 2490	2219 / 2491
F-350 (4x4 only)	05	2071 *	R-R		6781		4160	C-R	ND	6025	8616	ND	8615	ND	4354	2097 / 2490	2219 / 2491
F-350 (4x4 only)	99-04	2484 *	R-R	ND	6781		2223	R-R		6762			8613	ND	4354	2097 / 2490	2219 / 2491
F-350 (4x4 only)	84-98	2071 *	R-R		6781		2223	R-R		6762						2097 / 2490	2219 / 2491
F-350 (4x4 only)	63-83	2071 *	R-R		6781											2097 / 2490	2219 / 2491
F-450 (4x2 only)	08-10	2442	R-R		7714		4101	C-R	ND	6002						2097 / 2490	2219 / 2491
F-450 (4x4 only)	08-10	2442	R-R		7714		4160	C-R	ND	6025						2097 / 2490	2219 / 2491

SEE PAGE 54 FOR ADDITIONAL LIFTED/LOWERED VEHICLE APPLICATIONS & SPACERS

 ND= No Drill
 sw= Station Wagon
 fwd= Front Wheel Drive
 rwd= Rear Wheel Drive
 A.C.=Air Conversion
 C-R=Coil-Rite
 L-R=Level-Rite
 S-R=Sport-Rite
 R-R=Ride-Rite
 W-R=Work-Rite





Minimum Tire to Frame Clearance Requirements: * = 7.50" ** = 3.00" *** = 9.50" + = 8.00" ++ = 6.00" +++ = 6.50"
 -0000- While Supplies Last # = Use spacer kit 2366 with heavy duty package
 DO NOT EXCEED THE VEHICLE'S RECOMMENDED GROSS VEHICLE WEIGHT RATING (GVWR)

MODEL	YEAR	Air Leveling Rear					Air Leveling Front				Work-Rite			Shocks		Recommended Air Accessory Systems		
		REAR KIT	TYPE		SPRING ONLY		FRONT KIT	TYPE		SPRING ONLY	FRONT KIT		REAR KIT		FRONT	REAR	SINGLE	DUAL
Ford Pickup Trucks (with in bed hitch)																		
F-250 (Gasoline and 4x2 only)	11						4101	C-R	ND	6002							2097 / 2490	2219 / 2491
factory bed hitch		2520	R-R	ND	6401						8616	ND				4351	2097 / 2490	2219 / 2491
aftermarket bed hitch		2450	R-R	ND	6401						8616	ND				4351	2097 / 2490	2219 / 2491
F-250 (Diesel and 4x2 only)	11	2535	R-R	ND	6401		4101	C-R	ND	6002	8616	ND	8614	ND		4351	2097 / 2490	2219 / 2491
F-250 (4x2 only)	08-10	2450	R-R	ND	6401		4101	C-R	ND	6002	8616	ND	8614	ND		4351	2097 / 2490	2219 / 2491
F-250 (4x2 only)	05-07	2398	R-R	ND	6401		4101	C-R	ND	6002	8616	ND	8614	ND		4351	2097 / 2490	2219 / 2491
F-250 Over 8500 GVWR (4x2 only)	99-04	2330	R-R	ND	6401		4101	C-R	ND	6002			8612	ND		4351	2097 / 2490	2219 / 2491
F-250 Over 8500 GVWR (4x2 only)	84-98	2071 *	R-R		6781		4101	C-R	ND	6002							2097 / 2490	2219 / 2491
F-250 Over 8500 GVWR (4x2 only)	69-83	2071 *	R-R		6781												2097 / 2490	2219 / 2491
F-250 (Gasoline and 4x4 only)	11						4160	C-R	ND	6025	8616	ND					2097 / 2490	2219 / 2491
factory bed hitch		2520	R-R	ND	6401								8614	ND		4351	2097 / 2490	2219 / 2491
aftermarket bed hitch		2450	R-R	ND	6401								8614	ND		4351	2097 / 2490	2219 / 2491
F-250 (Diesel and 4x4 only)	11	2535	R-R	ND	6401		4160	C-R	ND	6025							2097 / 2490	2219 / 2491
F-250 (4x4 only)	08-10	2450	R-R	ND	6401		4160	C-R	ND	6025	8616	ND	8614	ND		4351	2097 / 2490	2219 / 2491
F-250 (4x4 only)	05-07	2400	R-R	ND	6401		4160	C-R	ND	6025	8616	ND	8614	ND		4351	2097 / 2490	2219 / 2491
F-250 Over 8500 GVWR (4x4 only)	99-04	2330	R-R	ND	6401		2223	R-R		6762			8612	ND		4351	2097 / 2490	2219 / 2491
F-350 (Gasoline and 4x2 only)	11						4101	C-R	ND	6002	8616	ND					2097 / 2490	2219 / 2491
factory bed hitch		2520	R-R	ND	6401								8615	ND		4351	2097 / 2490	2219 / 2491
aftermarket bed hitch		2450	R-R	ND	6401								8615	ND		4351	2097 / 2490	2219 / 2491
F-350 (Diesel and 4x2 only)	11	2535	R-R	ND	6401		4101	C-R	ND	6002	8616	ND	8615	ND			2097 / 2490	2219 / 2491
F-350 (4x2 only)	08-10	2450	R-R	ND	6401		4101	C-R	ND	6002	8616	ND	8615	ND		4351	2097 / 2490	2219 / 2491
F-350 (4x2 only)	06-07	2398	R-R	ND	6401		4101	C-R	ND	6002	8616	ND	8615	ND		4351	2097 / 2490	2219 / 2491
F-350 (4x2 only)	05	2398	R-R	ND	6401		4160	C-R	ND	6025	8616	ND	8615	ND		4351	2097 / 2490	2219 / 2491
F-350 (4x2 only) (not V10 gas w/extended cab and 8' bed)	99-04	2330	R-R	ND	6401		4101	C-R	ND	6002			8613	ND		4351	2097 / 2490	2219 / 2491
F-350 (Gasoline and 4x4 only)	11						4160	C-R	ND	6025	8616	ND					2097 / 2490	2219 / 2491
factory bed hitch		2520	R-R	ND	6401								8615	ND		4351	2097 / 2490	2219 / 2491
aftermarket bed hitch		2450	R-R	ND	6401								8615	ND		4351	2097 / 2490	2219 / 2491
F-350 (Diesel and 4x4 only)	11	2535	R-R	ND	6401		4160	C-R	ND	6025	8616	ND	8615	ND			2097 / 2490	2219 / 2491
F-350 (4x4 only)	08-10	2450	R-R	ND	6401		4160	C-R	ND	6025	8616	ND	8615	ND		4354	2097 / 2490	2219 / 2491
F-350 (4x4 only)	06-07	2400	R-R	ND	6401		4160	C-R	ND	6025	8616	ND	8615	ND		4354	2097 / 2490	2219 / 2491
F-350 (4x4 only)	05	2400	R-R	ND	6401		4160	C-R	ND	6025	8616	ND	8615	ND		4354	2097 / 2490	2219 / 2491
F-350 (4x4 only)	99-04	2330	R-R	ND	6401		2223	R-R		6762			8613	ND		4354	2097 / 2490	2219 / 2491
F-450 (4x2 only)	11	2535	R-R	ND	6401		4101	C-R	ND	6002							2097 / 2490	2219 / 2491
F-450 (4x2 only)	08-10	2446	R-R	ND	7714		4101	C-R	ND	6002							2097 / 2490	2219 / 2491
F-450 (4x4 only)	11	2535	R-R	ND	6401		4160	C-R	ND	6025							2097 / 2490	2219 / 2491
F-450 (4x4 only)	08-10	2446	R-R	ND	7714		4160	C-R	ND	6025							2097 / 2490	2219 / 2491
Ford Commercial Vehicles (vehicles without factory bed)																		
E-250 (cutaway)	07-08	2061	R-R	ND	6764		4101	C-R	ND	6002							2097 / 2490	2219 / 2491
E-350 (with dual rear wheels)	92-08	2061	R-R	ND	6764		4101	C-R	ND	6002			8618	ND			2097 / 2490	2219 / 2491
E-350 (may require tailpipe modification)	75-91	2032	R-R	ND	6859		4101	C-R	ND	6002							2097 / 2490	2219 / 2491
E-450	08-11	2458	R-R	ND	6397		4101	C-R	ND	6002							2097 / 2490	2219 / 2491

SEE PAGE 54 FOR ADDITIONAL LIFTED/LOWERED VEHICLE APPLICATIONS & SPACERS

 ND= No Drill A.C.=Air Conversion R-R=Ride-Rite
 sw= Station Wagon C-R=Coil-Rite W-R=Work-Rite
 fwd= Front Wheel Drive L-R=Level-Rite
 rwd= Rear Wheel Drive S-R=Sport-Rite





Minimum Tire to Frame Clearance Requirements: * = 7.50" ** = 3.00" *** = 9.50" + = 8.00" ++ = 6.00" +++ = 6.50"
 -0000- While Supplies Last # = Use spacer kit 2366 with heavy duty package
 DO NOT EXCEED THE VEHICLE'S RECOMMENDED GROSS VEHICLE WEIGHT RATING (GVWR)

MODEL	YEAR	Air Leveling Rear				Air Leveling Front				Work-Rite			Shocks		Recommended Air Accessory Systems			
		REAR KIT	TYPE		SPRING ONLY	FRONT KIT	TYPE		SPRING ONLY	FRONT KIT		REAR KIT		FRONT	REAR	SINGLE	DUAL	
Ford Commercial Vehicles (vehicles without factory bed) continued																		
E-450	08-11	2458	R-R	ND	6397					4101	C-R	ND	6002				2097 / 2490	2219 / 2491
E-450	96-07	2377	R-R	ND	6397					4101	C-R	ND	6002				2097 / 2490	2219 / 2491
E-450 (requires 2" clearance above frame)	96-11	2153 +	R-R		6781					4101	C-R	ND	6002				2097 / 2490	2219 / 2491
F-350 (4x2, 4x4)	05-08	2176 *	R-R		6781					4160	C-R	ND	6025				2097 / 2490	2219 / 2491
F-350 (4x2 only)	99-04	2176 *	R-R		6781					4101	C-R	ND	6002				2097 / 2490	2219 / 2491
F-350 (4x4 only)	99-04	2176 *	R-R		6781					2223	R-R		6762				2097 / 2490	2219 / 2491
F-450 (4x2, 4x4)	05-11	2176 *	R-R		6781					4160	C-R	ND	6025				2097 / 2490	2219 / 2491
F-450 (4x2, 4x4)	99-04	2176 *	R-R		6781					2189	R-R	ND	6762				2097 / 2490	2219 / 2491
F-550 (4x2, 4x4) (requires 2" clearance above frame)	05-11	2404 ***	R-R		7714					4160	C-R	ND	6025				2097 / 2490	2219 / 2491
F-550 (4x2, 4x4) (requires 2" clearance above frame)	99-04	2404 ***	R-R		7714					2189	R-R	ND	6762				2097 / 2490	2219 / 2491
F-650	02-09		R-R							2363	R-R		6873				2097 / 2490	2219 / 2491
LCF-45, LCF-55 (with side fuel tanks for rear kit) (rear kit does not fit 115" wb)	06-09	-2437-	R-R		5405					-2438-	R-R		6397				2097 / 2490	2219 / 2491
F59	11	2170 +	R-R		6781					2070	R-R		0335				2097 / 2490	2219 / 2491
Ford Motorhomes Class "C" Vans																		
E-350 (with dual rear wheels)	92-11	2061	R-R	ND	6764					4101	C-R	ND	6002				2097 / 2490	2219 / 2491
E-350 (may require tailpipe modification)	75-91	2032	R-R	ND	6859					4101	C-R	ND	6002				2097 / 2490	2219 / 2491
E-450	08-11	2458	R-R	ND	6397					4101	C-R	ND	6002				2097 / 2490	2219 / 2491
E-450	96-07	2377	R-R	ND	6397					4101	C-R	ND	6002				2097 / 2490	2219 / 2491
E-450 (requires 2" clearance above frame)	96-11	2153 +	R-R		6781					4101	C-R	ND	6002				2097 / 2490	2219 / 2491
Ford Motorhomes Class "A"																		
E33 (with front coil springs)	92-96	2061	R-R	ND	6764					4101	C-R	ND	6002				2097 / 2490	2219 / 2491
E33 (with front coil springs)	86-91	2032	R-R	ND	6859					4101	C-R	ND	6002				2097 / 2490	2219 / 2491
F53 (24,000, 26,000 GVWR) (not Thor m/h)	08-10	2474 +	R-R		6781					2476	R-R	ND	7689				2097 / 2490	2219 / 2491
F53 (16,000 to 22,000 GVWR) (not Thor m/h)	08-10	2170 +	R-R		6781					2475	R-R		6873				2097 / 2490	2219 / 2491
F53 (16,000, 18,000 GVWR) (not Thor m/h)	99-07	2170 +	R-R		6781					2070	R-R		0335				2097 / 2490	2219 / 2491
F53	90-98	2068 +	R-R		0335					2070	R-R		0335				2097 / 2490	2219 / 2491
Freightliner Vans																		
Sprinter 2500	02-06	2312 +++	S-R		9002												2158 / 2490	2178 / 2491
Sprinter 3500 (cab & chassis)	02-06	2382	R-R		6781												2158 / 2490	2178 / 2491
Sprinter 3500 (van and cab & chassis)	02-06	2425	R-R		6781												2158 / 2490	2178 / 2491
Freightliner/Oshkosh/John Deere Motorhomes Class "A"																		
"M" and "X" chassis (not XC21) (below 22,000 GVWR)	94-98	2071 *	R-R		6781												2097 / 2490	2219 / 2491
Honda Cars																		
CR-Z	11	4183	C-R	ND	6027												2158 / 2490	2178 / 2491
Fit	10	4183	C-R	ND	6027												2158 / 2490	2178 / 2491
Insight	10	4183	C-R	ND	6027												2158 / 2490	2178 / 2491

SEE PAGE 54 FOR ADDITIONAL LIFTED/LOWERED VEHICLE APPLICATIONS & SPACERS

 ND= No Drill A.C.=Air Conversion R-R=Ride-Rite
 sw= Station Wagon C-R=Coil-Rite W-R=Work-Rite
 fwd= Front Wheel Drive L-R=Level-Rite
 rwd= Rear Wheel Drive S-R=Sport-Rite





Minimum Tire to Frame Clearance Requirements: * = 7.50" ** = 3.00" *** = 9.50" + = 8.00" ++ = 6.00" +++ = 6.50"
 -0000- While Supplies Last # = Use spacer kit 2366 with heavy duty package
 DO NOT EXCEED THE VEHICLE'S RECOMMENDED GROSS VEHICLE WEIGHT RATING (GVWR)

MODEL	YEAR	Air Leveling Rear					Air Leveling Front				Work-Rite			Shocks		Recommended Air Accessory Systems		
		REAR KIT	TYPE		SPRING ONLY		FRONT KIT	TYPE		SPRING ONLY	FRONT KIT		REAR KIT		FRONT	REAR	SINGLE	DUAL
Honda Vans																		
Odyssey	05-10	4179	C-R		6020												2158 / 2490	2178 / 2491
Odyssey	99-04	4138	C-R		6017												2158 / 2490	2178 / 2491
Odyssey	96-98	-4133-	C-R	ND	6018												2158 / 2490	2178 / 2491
Honda SUVs																		
Passport (4x2, 4x4)	98-02	4136	C-R	ND	6014												2158 / 2490	2178 / 2491
Pilot	05-10	4179	C-R		6020												2158 / 2490	2178 / 2491
Pilot	03-04	4138	C-R	ND	6017												2158 / 2490	2178 / 2491
HUMMER SUVs																		
H3, H3T, H3X, H3 Alpha	06-09	-2460-	R-R	ND	6781												2158 / 2490	2178 / 2491
H2, H2 SUT (with rear coil springs)	03-09	4108	C-R	ND	6003							8628	ND				2158 / 2490	2178 / 2491
Hyundai Car																		
Accent	07-10	4136	C-R	ND	6014												2158 / 2490	2178 / 2491
Hyundai Van																		
Entourage	07-09	4138	C-R		6017												2158 / 2490	2178 / 2491
Hyundai SUVs																		
Santa Fe	07-10	4170	C-R		6017												2158 / 2490	2178 / 2491
Santa Fe	01-06	4167	C-R	ND	6027												2158 / 2490	2178 / 2491
Veracruz	07-10	4170	C-R		6017												2158 / 2490	2178 / 2491
Infiniti SUVs																		
FX45 (4x2, 4x4)	03-08	4118	C-R	ND	6018												2158 / 2490	2178 / 2491
QX56	05-09	4150	C-R	ND	6023												2158 / 2490	2178 / 2491
International Commercial Vehicle (vehicles without factory bed)																		
Citystar CF 500, CF 600 (with side fuel tanks for rear kit) (rear kit does not fit 115" wb)	06-09	-2437-	R-R		5405		-2438-	R-R		6397							2097 / 2490	2219 / 2491
Isuzu Van																		
Oasis	96-98	-4133-	C-R	ND	6018												2158 / 2490	2178 / 2491
Isuzu SUVs																		
Amigo	98-00	4103	C-R	ND	6014												2158 / 2490	2178 / 2491
Axiom	02-03	4136	C-R	ND	6014												2158 / 2490	2178 / 2491
Rodeo, Rodeo Sport	98-04	4136	C-R	ND	6014												2158 / 2490	2178 / 2491
Trooper	98-04	-4143-	C-R	ND	6016												2158 / 2490	2178 / 2491
Trooper	92-97	4106	C-R	ND	6015												2158 / 2490	2178 / 2491
Isuzu Truck																		
Isuzu 290i, 370i (4x2, 4x4)	06-09	2384	R-R	ND	6397												2158 / 2490	2178 / 2491
Isuzu Commercial Vehicle (vehicles without factory bed)																		
N-Series	96-10	2449	S-R		9001		2440	R-R		6868							2097 / 2490	2219 / 2491
Jeep SUVs																		
Commander (4x2, 4x4)	06-10	4157	C-R	ND	6005												2158 / 2490	2178 / 2491
Grand Cherokee (4x2, 4x4)	11	4184	C-R	ND	6025												2158 / 2490	2178 / 2491
Grand Cherokee (4x2, 4x4)	05-10	4157	C-R		6005												2158 / 2490	2178 / 2491
Grand Cherokee (4x2, 4x4) (not "up country")	92-98	4118	C-R	ND	6018												2158 / 2490	2178 / 2491
Grand Wagoneer (2x4, 4x4)	92-98	4118	C-R	ND	6018												2158 / 2490	2178 / 2491

SEE PAGE 54 FOR ADDITIONAL LIFTED/LOWERED VEHICLE APPLICATIONS & SPACERS

 ND= No Drill A.C.=Air Conversion R-R=Ride-Rite
 sw= Station Wagon C-R=Coil-Rite W-R=Work-Rite
 fwd= Front Wheel Drive L-R=Level-Rite
 rwd= Rear Wheel Drive S-R=Sport-Rite





Minimum Tire to Frame Clearance Requirements: * = 7.50" ** = 3.00" *** = 9.50" + = 8.00" ++ = 6.00" +++ = 6.50"
 -0000- While Supplies Last # = Use spacer kit 2366 with heavy duty package
 DO NOT EXCEED THE VEHICLE'S RECOMMENDED GROSS VEHICLE WEIGHT RATING (GVWR)

MODEL	YEAR	Air Leveling Rear				Air Leveling Front				Work-Rite			Shocks		Recommended Air Accessory Systems		
		REAR KIT	TYPE		SPRING ONLY	FRONT KIT	TYPE		SPRING ONLY	FRONT KIT		REAR KIT		FRONT	REAR	SINGLE	DUAL
Jeep SUVs Continued																	
Liberty (4x2, 4x4)	08-11	4170	C-R		6017											2158 / 2490	2178 / 2491
Liberty (4x2, 4x4)	02-07	4146	C-R		6005											2158 / 2490	2178 / 2491
Summit (sw only)	92-93	4105	C-R	ND	6013											2158 / 2490	2178 / 2491
Wrangler Mountain (4x4 only)	11	4173	C-R	ND	6006											2158 / 2490	2178 / 2491
Wrangler Rubicon (4x4 only)	07-11	4172	C-R	ND	6007											2158 / 2490	2178 / 2491
Wrangler Sahara (4x2, 4x4)	07-11	4173	C-R	ND	6006											2158 / 2490	2178 / 2491
Wrangler Sport (4x4 only)	10-11	4173	C-R	ND	6006											2158 / 2490	2178 / 2491
Wrangler X (4x2, 4x4)	07-09	4173	C-R	ND	6006											2158 / 2490	2178 / 2491
Wrangler Unlimited Mountain (4x4 only)	11	4173	C-R	ND	6006											2158 / 2490	2178 / 2491
Wrangler Unlimited Rubicon (4x4 only)	07-10	4172	C-R	ND	6007											2158 / 2490	2178 / 2491
Wrangler Unlimited Sahara (4x2, 4x4)	07-11	4173	C-R	ND	6006											2158 / 2490	2178 / 2491
Wrangler Unlimited Sport (4x2, 4x4)	10-11	4173	C-R	ND	6006											2158 / 2490	2178 / 2491
Wrangler Unlimited X (4x2, 4x4)	07-09	4173	C-R	ND	6006											2158 / 2490	2178 / 2491
Wrangler (4x2, 4x4)	97-06	4157	C-R		6005											2158 / 2490	2178 / 2491
Kia Car																	
Rio	11	4140	C-R		6018											2158 / 2490	2178 / 2491
Kia Van																	
Sodona	06-11	4138	C-R		6017											2158 / 2490	2178 / 2491
Kia SUV																	
Sorento	03-10	4153	C-R	ND	6024											2158 / 2490	2178 / 2491
Landrover SUVs																	
Defender 90	90-97	4121	C-R	ND	6003											2158 / 2490	2178 / 2491
Discovery (with rear coil springs)	90-04	4121	C-R	ND	6003											2158 / 2490	2178 / 2491
Range Rover	90-96	4121	C-R	ND	6003											2158 / 2490	2178 / 2491
Lexus SUVs																	
LX 450	96-98	4124	C-R	ND	6007											2158 / 2490	2178 / 2491
LX 470	99-07	4124	C-R	ND	6007											2158 / 2490	2178 / 2491
Lincoln Cars																	
Continental (with rear coil springs)	82-88	4106	C-R	ND	6015											2158 / 2490	2178 / 2491
Mark IV (with rear coil springs)	84-87	4106	C-R	ND	6015											2158 / 2490	2178 / 2491
MKS	09-11	4178	C-R	ND	6014											2158 / 2490	2178 / 2491
MKZ	11	4170	C-R	ND	6017											2158 / 2490	2178 / 2491
Towncar	80-89	4108	C-R	ND	6003											2158 / 2490	2178 / 2491
Lincoln CUVs																	
MKT	09-11	4178	C-R	ND	6014											2158 / 2490	2178 / 2491
MKX	07-09	4171	C-R	ND	6020											2158 / 2490	2178 / 2491
Lincoln Trucks																	
Mark LT (4x2, 4x4)	09	2525 +	R-R	ND	6781											2158 / 2490	2178 / 2491
Mark LT (4x2, 4x4)	05-08	2350	R-R	ND	6397											2158 / 2490	2178 / 2491
Mazda Car																	
Mazda6 (not sport wagon)	06-10	4168	C-R	ND	6027											2158 / 2490	2178 / 2491

SEE PAGE 54 FOR ADDITIONAL LIFTED/LOWERED VEHICLE APPLICATIONS & SPACERS

 ND= No Drill A.C.=Air Conversion R-R=Ride-Rite
 sw= Station Wagon C-R=Coil-Rite W-R=Work-Rite
 fwd= Front Wheel Drive L-R=Level-Rite
 rwd= Rear Wheel Drive S-R=Sport-Rite

Minimum Tire to Frame Clearance Requirements: * = 7.50" ** = 3.00" *** = 9.50" + = 8.00" ++ = 6.00" +++ = 6.50"
 -0000- While Supplies Last # = Use spacer kit 2366 with heavy duty package
 DO NOT EXCEED THE VEHICLE'S RECOMMENDED GROSS VEHICLE WEIGHT RATING (GVWR)

MODEL	YEAR	Air Leveling Rear					Air Leveling Front				Work-Rite			Shocks		Recommended Air Accessory Systems		
		REAR KIT	TYPE		SPRING ONLY		FRONT KIT	TYPE		SPRING ONLY	FRONT KIT		REAR KIT		FRONT	REAR	SINGLE	DUAL
Mazda Vans																		
Mazda5	06-10	4168	C-R	ND	6027												2158 / 2490	2178 / 2491
MPV	05-06	-4140-	C-R	ND	6018												2158 / 2490	2178 / 2491
MPV	96-98	4105	C-R	ND	6013												2158 / 2490	2178 / 2491
Mazda CUV																		
CX7	07-10	4167	C-R	ND	6027												2158 / 2490	2178 / 2491
Mazda Pickup Truck																		
Pickup (4x2 only)	72-90	1130 **	R-R	ND	6873												2158 / 2490	2178 / 2491
Mercury Cars																		
Capri	79-86	4103	C-R	ND	6014												2158 / 2490	2178 / 2491
Colony Park	83-97	4108	C-R	ND	6003												2158 / 2490	2178 / 2491
Cougar	92-97	4105	C-R	ND	6013												2158 / 2490	2178 / 2491
Cougar	89-91	4104	C-R	ND	6012												2158 / 2490	2178 / 2491
Cougar	80-88	4106	C-R	ND	6015												2158 / 2490	2178 / 2491
Grand Marquis	98-08	4107	C-R	ND	6021												2158 / 2490	2178 / 2491
Grand Marquis	83-97	4108	C-R	ND	6003												2158 / 2490	2178 / 2491
Marquis	83-86	4103	C-R	ND	6014												2158 / 2490	2178 / 2491
Milan	06-08	4168	C-R	ND	6027												2158 / 2490	2178 / 2491
Sable (sw only)	99-06	-4141-	C-R	ND	6005												2158 / 2490	2178 / 2491
Sable (sw only)	86-98	4105	C-R	ND	6013												2158 / 2490	2178 / 2491
Mercury Van																		
Monterey	04-07	4151	C-R	ND	6016												2158 / 2490	2178 / 2491
Mitsubishi SUVs																		
Expo (4x2, 4x4)	92-93	4105	C-R	ND	6013												2158 / 2490	2178 / 2491
Montero Sport (4x2, 4x4)	99-04	-4137-	C-R	ND	6007												2158 / 2490	2178 / 2491
Outlander	07-10	4182	C-R	ND	6026												2158 / 2490	2178 / 2491
Mitsubishi Pickup Trucks																		
Raider Extended Cab (4x2, 4x4)	06-09	2378 +++	S-R		9000												2158 / 2490	2178 / 2491
Raider Double Cab (4x2, 4x4)	06-09	2379 +++	S-R		9000												2158 / 2490	2178 / 2491
Pickup (4x2 only)	69-96	1130 **	R-R	ND	6873												2158 / 2490	2178 / 2491
Mitsubishi Fuso Commercial Vehicle (vehicles without factory bed)																		
FE180	07-10	2449	S-R		9001												2097 / 2490	2219 / 2491
Nissan Cars																		
Altima	05-10	4105	C-R	ND	6013												2158 / 2490	2178 / 2491
Maxima	05-08	4105	C-R	ND	6013												2158 / 2490	2178 / 2491
Nissan Van																		
Quest	04-09	4118	C-R	ND	6018												2158 / 2490	2178 / 2491
Nissan SUVs																		
Armada (4x2, 4x4)	06-10	4150	C-R	ND	6023												2158 / 2490	2178 / 2491
Murano (4x2, 4x4)	09	4181	C-R	ND	6016												2158 / 2490	2178 / 2491
Murano (4x2, 4x4)	03-08	4118	C-R	ND	6018												2158 / 2490	2178 / 2491

SEE PAGE 54 FOR ADDITIONAL LIFTED/LOWERED VEHICLE APPLICATIONS & SPACERS

 ND= No Drill	A.C.=Air Conversion	R-R=Ride-Rite
sw= Station Wagon	C-R=Coil-Rite	W-R=Work-Rite
fwd= Front Wheel Drive	L-R=Level-Rite	
rwd= Rear Wheel Drive	S-R=Sport-Rite	

Minimum Tire to Frame Clearance Requirements: * = 7.50" ** = 3.00" *** = 9.50" + = 8.00" ++ = 6.00" +++ = 6.50"
 -0000- While Supplies Last # = Use spacer kit 2366 with heavy duty package
 DO NOT EXCEED THE VEHICLE'S RECOMMENDED GROSS VEHICLE WEIGHT RATING (GVWR)

MODEL	YEAR	Air Leveling Rear				Air Leveling Front				Work-Rite			Shocks		Recommended Air Accessory Systems	
		REAR KIT	TYPE		SPRING ONLY	FRONT KIT	TYPE		SPRING ONLY	FRONT KIT		REAR KIT		FRONT	REAR	SINGLE
Nissan SUVs Continued																
Pathfinder (4x2, 4x4)	06-10	4166	C-R	ND	6021										2158 / 2490	2178 / 2491
Pathfinder Armada (4x2, 4x4)	04-05	4150	C-R	ND	6023										2158 / 2490	2178 / 2491
Pathfinder (4x2, 4x4)	87-95	4106	C-R	ND	6015										2158 / 2490	2178 / 2491
Rogue (4x2, 4x4)	08-11	4181	C-R	ND	6024										2158 / 2490	2178 / 2491
Xterra (4x2, 4x4)	05-11	2409	S-R	ND	9002						8626	ND			2158 / 2490	2178 / 2491
Nissan Pickup Trucks																
Frontier (4x2, 4x4)	05-11	2403	R-R	ND	6766										2158 / 2490	2178 / 2491
Frontier (4x2 only)	01-04	2293	S-R	ND	9002										2158 / 2490	2178 / 2491
Pickup (4x2 only)	69-96	1130 **	R-R	ND	6873										2158 / 2490	2178 / 2491
Titan (4x2, 4x4)	04-10	2355	R-R	ND	6781						8601	ND			2158 / 2490	2178 / 2491
Oldsmobile Cars																
88 (rwd only)	85	-4116-	C-R	ND	6010										2158 / 2490	2178 / 2491
98 (not sw) (rwd only)	65-84	-4116-	C-R	ND	6010										2158 / 2490	2178 / 2491
Achieva	92-98	4104	C-R	ND	6012										2158 / 2490	2178 / 2491
Aurora	95-04	4105	C-R	ND	6013										2158 / 2490	2178 / 2491
Calais, Cutlass, Cutlass Supreme (not sw)	73-87	4114	C-R	ND	6008										2158 / 2490	2178 / 2491
Custom Cruiser (sw only)	77-93	-4116-	C-R	ND	6010										2158 / 2490	2178 / 2491
Cutlass Calais (fwd only)	85-91	4104	C-R	ND	6012										2158 / 2490	2178 / 2491
Cutlass Cierra	82-96	4103	C-R	ND	6014										2158 / 2490	2178 / 2491
Cutlass Cruiser (sw only) (fwd only)	84-95	4103	C-R	ND	6014										2158 / 2490	2178 / 2491
Cutlass, F-85, 442 (not sw)	67-72	-4113-	C-R	ND	6007										2158 / 2490	2178 / 2491
Delta 88 (not sw) (rwd only)	64-84	4116	C-R	ND	6010										2158 / 2490	2178 / 2491
Delta 88, 98 (fwd only)	85-99	4107	C-R	ND	6021										2158 / 2490	2178 / 2491
Firenza (fwd only)	82-88	4104	C-R	ND	6012										2158 / 2490	2178 / 2491
LSS	96-01	4107	C-R	ND	6021										2158 / 2490	2178 / 2491
Toronado	79-85	4106	C-R	ND	6015										2158 / 2490	2178 / 2491
Oldsmobile Van																
Silhouette	90-96	-4110-	C-R	ND	6015										2158 / 2490	2178 / 2491
Oldsmobile SUV																
Bravada (4x2, 4x4) (with rear coil springs)	02-05	4106	C-R	ND	6015										2158 / 2490	2178 / 2491
Plymouth Cars																
Acclaim	89-95	4105	C-R	ND	6013										2158 / 2490	2178 / 2491
Caravelle	85-88	4105	C-R	ND	6013										2158 / 2490	2178 / 2491
Reliant	81-94	4105	C-R	ND	6013										2158 / 2490	2178 / 2491
Sundance	87-93	4105	C-R	ND	6013										2158 / 2490	2178 / 2491
Plymouth Truck																
Arrow	80-93	1130 **	R-R	ND	6873										2158 / 2490	2178 / 2491
Pontiac Cars																
6000	82-91	4103	C-R	ND	6014										2158 / 2490	2178 / 2491
Bonneville (fwd only)	00-05	4105	C-R	ND	6013										2158 / 2490	2178 / 2491
Bonneville (fwd only)	87-99	4107	C-R	ND	6021										2158 / 2490	2178 / 2491

SEE PAGE 54 FOR ADDITIONAL LIFTED/LOWERED VEHICLE APPLICATIONS & SPACERS

ND= No Drill A.C.=Air Conversion R-R=Ride-Rite
 sw= Station Wagon C-R=Coil-Rite W-R=Work-Rite
 fwd= Front Wheel Drive L-R=Level-Rite
 rwd= Rear Wheel Drive S-R=Sport-Rite





Minimum Tire to Frame Clearance Requirements: * = 7.50" ** = 3.00" *** = 9.50" + = 8.00" ++ = 6.00" +++ = 6.50"
 -0000- While Supplies Last # = Use spacer kit 2366 with heavy duty package
 DO NOT EXCEED THE VEHICLE'S RECOMMENDED GROSS VEHICLE WEIGHT RATING (GVWR)

MODEL	YEAR	Air Leveling Rear				Air Leveling Front				Work-Rite			Shocks		Recommended Air Accessory Systems		
		REAR KIT	TYPE	⊕	SPRING ONLY	FRONT KIT	TYPE	⊕	SPRING ONLY	FRONT KIT	⊕	REAR KIT	⊕	FRONT	REAR	SINGLE	DUAL
Pontiac Cars Continued																	
Firebird, Trans Am	82-02	4103	C-R	ND	6014											2158 / 2490	2178 / 2491
Grand Am	85-97	4104	C-R	ND	6012											2158 / 2490	2178 / 2491
Grand Am, Le Mans, Grand Le Mans	73-82	4114	C-R	ND	6008											2158 / 2490	2178 / 2491
Grand Prix	73-87	4114	C-R	ND	6008											2158 / 2490	2178 / 2491
Grand Prix	69-72	-4113-	C-R	ND	6007											2158 / 2490	2178 / 2491
Grand Prix	65-68	4114	C-R	ND	6008											2158 / 2490	2178 / 2491
Grandville	71-73	-4116-	C-R	ND	6010											2158 / 2490	2178 / 2491
J-2000, Sunbird	82-94	4104	C-R	ND	6012											2158 / 2490	2178 / 2491
Le Mans	88-92	4104	C-R	ND	6012											2158 / 2490	2178 / 2491
Le Mans, Custom, 'S', Judge, Tempest, GTO, GT37 (not sw)	68-72	-4113-	C-R	ND	6007											2158 / 2490	2178 / 2491
Phoenix	80-84	4103	C-R	ND	6014											2158 / 2490	2178 / 2491
Safari (sw only)	87-89	-4116-	C-R	ND	6010											2158 / 2490	2178 / 2491
Pontiac Van																	
Transport APV	90-96	-4110-	C-R	ND	6015											2158 / 2490	2178 / 2491
Pontiac SUV																	
Torrent (4x2, 4x4)	05-07	4167	C-R	ND	6027											2158 / 2490	2178 / 2491
Saturn Van																	
Relay	05-07	4155	C-R	ND	6020											2158 / 2490	2178 / 2491
Saturn SUV																	
Vue	02-07	4167	C-R	ND	6027											2158 / 2490	2178 / 2491
Scion Cars																	
xA	04-07	4136	C-R	ND	6014											2158 / 2490	2178 / 2491
xB	08-11	4136	C-R	ND	6014											2158 / 2490	2178 / 2491
xD	08-10	4156	C-R	ND	6015											2158 / 2490	2178 / 2491
Spartan Motorhome Class "A"																	
EC2000 (round axle only)	91-96									-2102-	R-R	ND	6762			2097 / 2490	2219 / 2491
Sterling Commercial Vehicles (vehicles without factory bed)																	
Bullet (4x2, 4x4) (cab & chassis)	08-09	2478 +	R-R		6781											2097 / 2490	2219 / 2491
Suzuki Car																	
SX4 (crossover, sedan, sport)	10	4183	C-R	ND	6027											2158 / 2490	2178 / 2491
Suzuki SUV																	
Grand Vitara	10	4182	C-R	ND	6026											2158 / 2490	2178 / 2491
Toyota Cars																	
ECHO	01-05	4118	C-R	ND	6018											2158 / 2490	2178 / 2491
Prius	10	4136	C-R	ND	6014											2158 / 2490	2178 / 2491
Yaris	07-10	4136	C-R	ND	6014											2158 / 2490	2178 / 2491
Toyota Vans																	
Siena (not AWD)	04-11	4155	C-R	ND	6020											2158 / 2490	2178 / 2491
Siena	98-03	4118	C-R	ND	6018											2158 / 2490	2178 / 2491
Van (with rear coil springs)	64-89	4112	C-R	ND	6006											2158 / 2490	2178 / 2491

SEE PAGE 54 FOR ADDITIONAL LIFTED/LOWERED VEHICLE APPLICATIONS & SPACERS

⊕ ND= No Drill	A.C.=Air Conversion	R-R=Ride-Rite
sw= Station Wagon	C-R=Coil-Rite	W-R=Work-Rite
fwd= Front Wheel Drive	L-R=Level-Rite	
rwd= Rear Wheel Drive	S-R=Sport-Rite	





Minimum Tire to Frame Clearance Requirements: * = 7.50" ** = 3.00" *** = 9.50" + = 8.00" ++ = 6.00" +++ = 6.50"
 -0000- While Supplies Last # = Use spacer kit 2366 with heavy duty package
 DO NOT EXCEED THE VEHICLE'S RECOMMENDED GROSS VEHICLE WEIGHT RATING (GVWR)

MODEL	YEAR	Air Leveling Rear				Air Leveling Front				Work-Rite			Shocks		Recommended Air Accessory Systems		
		REAR KIT	TYPE		SPRING ONLY	FRONT KIT	TYPE		SPRING ONLY	FRONT KIT		REAR KIT		FRONT	REAR	SINGLE	DUAL
Toyota SUVs																	
RAV4 (4x2, 4x4)	07-10	4174	C-R	ND	6028											2158 / 2490	2178 / 2491
RAV4 (4x2, 4x4)	96-98	4104	C-R	ND	6012											2158 / 2490	2178 / 2491
FJ Cruiser	07-09	4173	C-R	ND	6006											2158 / 2490	2178 / 2491
4Runner	98-10	4135	C-R	ND	6024											2158 / 2490	2178 / 2491
4Runner	96-97	4123	C-R	ND	6021											2158 / 2490	2178 / 2491
4Runner	90-95	4112	C-R	ND	6006											2158 / 2490	2178 / 2491
Sequoia	08-10	4164	C-R	ND	6009											2158 / 2490	2178 / 2491
Sequoia	01-07	4124	C-R	ND	6007											2158 / 2490	2178 / 2491
Land Cruiser	08-10	4164	C-R	ND	6009											2158 / 2490	2178 / 2491
Land Cruiser	91-07	4124	C-R	ND	6007											2158 / 2490	2178 / 2491
Toyota Pickup Trucks																	
Pickup (4x2 only)	69-95	1130 **	R-R	ND	6873											2158 / 2490	2178 / 2491
Pickup (4x4 only)	84-95	2116	R-R	ND	6781											2158 / 2490	2178 / 2491
T 100 (4x2 only)	93-98	2115	R-R	ND	6781											2158 / 2490	2178 / 2491
T 100 (4x4 only)	93-98	2116	R-R	ND	6781											2158 / 2490	2178 / 2491
Tacoma (4x2 only)	05-11	2410	R-R	ND	6762											2158 / 2490	2178 / 2491
Tacoma (4x2 only)	95-04	2213	R-R		6762											2158 / 2490	2178 / 2491
Tacoma Prerunner (4x2 only)	05-11	2407	R-R	ND	6766											2158 / 2490	2178 / 2491
Tacoma Prerunner (4x2 only)	95-04	2304	R-R		6781											2158 / 2490	2178 / 2491
Tacoma (4x4 only)	05-11	2407	R-R	ND	6766											2158 / 2490	2178 / 2491
Tacoma (4x4 only)	95-04	2304 #	R-R		6781											2158 / 2490	2178 / 2491
Tundra (4x2, 4x4)	07-11	2445	R-R	ND	6410											2158 / 2490	2178 / 2491
Tundra (4x2 only)	00-06	2212	S-R		9001											2158 / 2490	2178 / 2491
Tundra TRD (4x2 only)	00-06	2245	R-R		6781											2158 / 2490	2178 / 2491
Tundra (4x4 only)	00-06	2245	R-R		6781											2158 / 2490	2178 / 2491
Volkswagen Cars																	
CC	09-11	4176	C-R	ND	6027											2158 / 2490	2178 / 2491
Eos	07-11	4176	C-R	ND	6027											2158 / 2490	2178 / 2491
GTI	07-11	4176	C-R	ND	6027											2158 / 2490	2178 / 2491
Golf TDI	11	4176	C-R	ND	6027											2158 / 2490	2178 / 2491
Jetta (not TDI)	07-10	4175	C-R	ND	6026											2158 / 2490	2178 / 2491
Jetta Sport Wagen	09-10	4176	C-R	ND	6027											2158 / 2490	2178 / 2491
Passat (not TDI)	98-06	4104	C-R	ND	6012											2158 / 2490	2178 / 2491
Passat Wagen	07-09	4175	C-R	ND	6026											2158 / 2490	2178 / 2491
Volkswagen Vans																	
Routan	09-11	4169	C-R		6013											2158 / 2490	2178 / 2491
Euro Van, T-4	85-03	4117	C-R	ND	6004											2158 / 2490	2178 / 2491

SEE PAGE 54 FOR ADDITIONAL LIFTED/LOWERED VEHICLE APPLICATIONS & SPACERS

 ND= No Drill
 sw= Station Wagon
 fwd= Front Wheel Drive
 rwd= Rear Wheel Drive
 A.C.=Air Conversion
 C-R=Coil-Rite
 L-R=Level-Rite
 S-R=Sport-Rite
 R-R=Ride-Rite
 W-R=Work-Rite

Minimum Tire to Frame Clearance Requirements: * = 7.50" ** = 3.00" *** = 9.50" + = 8.00" ++ = 6.00" +++ = 6.50"
 -0000- While Supplies Last # = Use spacer kit 2366 with heavy duty package
 DO NOT EXCEED THE VEHICLE'S RECOMMENDED GROSS VEHICLE WEIGHT RATING (GVWR)

MODEL	YEAR	Air Leveling Rear					Air Leveling Front				Work-Rite			Shocks		Recommended Air Accessory Systems		
		REAR KIT	TYPE		SPRING ONLY		FRONT KIT	TYPE		SPRING ONLY	FRONT KIT		REAR KIT		FRONT	REAR	SINGLE	DUAL
Volkswagen SUV																		
Tiguan	09-11	4176	C-R	ND	6027												2158 / 2490	2178 / 2491
Workhorse Motorhomes Class "A"																		
P30, P32 10,500 to 17,000 GVWR	00-08	2147 *	R-R		6781												2097 / 2490	2219 / 2491
P30, P32, W16 10,500 to 17,000 GVWR	00-07	2085	R-R	ND	6781												2097 / 2490	2219 / 2491
W20, W22, W24	04-09	2347	R-R		5405	2284	R-R		6781								2097 / 2490	2219 / 2491
UFO	07-09	2457	R-R	ND	7689	2477	R-R		7689								2097 / 2490	2219 / 2491

NOTES:

SEE PAGE 54 FOR ADDITIONAL LIFTED/LOWERED VEHICLE APPLICATIONS & SPACERS

 ND= No Drill	A.C.=Air Conversion	R-R=Ride-Rite
sw= Station Wagon	C-R=Coil-Rite	W-R=Work-Rite
fwd= Front Wheel Drive	L-R=Level-Rite	
rwd= Rear Wheel Drive	S-R=Sport-Rite	

Minimum Tire to Frame Clearance Requirements: * = 7.50" ** = 3.00" *** = 9.50" + = 8.00" ++ = 6.00" +++ = 6.50"
 -0000- While Supplies Last # = Use spacer kit 2366 with heavy duty package
 DO NOT EXCEED THE VEHICLE'S RECOMMENDED GROSS VEHICLE WEIGHT RATING (GVWR)

Kits and quantity required for kit installation												
Vehicle	Year	Lifted	Master kit W28-760	2 Leaf springs	1 Links		1 Differential bracket	1 Frame (eye) bracket	1 Air spring kit	1 Air control kit	1 Load adaptive shocks	Availability Date
Chevrolet/GMC Pickup Trucks												
2500 (4x2,4x4), w/10.5" axle	2011		0036	W4T-000-G05S	W4T-000-GL03		W4T-000-GD04	W4T-000-GB05	W4T-000-1506	W4T-000-1575	WR1-760-4357	3/2011
3500 (4x2,4x4) SRW/DRW, w/11.5" axle	2011		0037	W4T-000-G06S	W4T-000-GL03		W4T-000-GD05	W4T-000-GB05	W4T-000-1506	W4T-000-1575	WR1-760-4357	3/2011
2500 (4x2, 4x4) Long Bed, w/10.5" axle	05-10		0028	W4T-000-G01S	W4T-000-GL01		W4T-000-GD01	W4T-000-GB02	W4T-000-1503	W4T-000-1575	WR1-760-4353	3/2011
2500 (4x2, 4x4) Short Bed, w/10.5" axle	05-10		0027	W4T-000-G01S	W4T-000-GL01		W4T-000-GD01	W4T-000-GB01	W4T-000-1503	W4T-000-1575	WR1-760-4353	3/2011
3500 (4x2, 4x4) Long Bed, SRW/DRW, w/11.5" axle	05-10		0030	W4T-000-G02S	W4T-000-GL01		W4T-000-GD02	W4T-000-GB02	W4T-000-1503	W4T-000-1575	WR1-760-4355	3/2011
3500 (4x2, 4x4) Short Bed SRW/DRW, w/11.5" axle	05-10		0029	W4T-000-G02S	W4T-000-GL01		W4T-000-GD02	W4T-000-GB01	W4T-000-1503	W4T-000-1575	WR1-760-4355	3/2011
Dodge Pickup Trucks												
Ram 2500 (4x2) SRW Regular and Quad Cab, w/10.5" axle	10-11		0038	W4T-000-C06S	W4T-000-CL01		W4T-000-CD01	W4T-000-CB04	W4T-000-1504	W4T-000-1575	WR1-760-4350	11/2010
Ram 2500 (4x2) SRW Mega Cab, w/10.5" axle	10-11		0039	W4T-000-C07S	W4T-000-CL01		W4T-000-CD01	W4T-000-CB04	W4T-000-1504	W4T-000-1575	WR1-760-4350	11/2010
Ram 2500 (4x4) SRW Regular and Quad Cab, w/10.5" axle	10-11		0040	W4T-000-C06S	W4T-000-CL01		W4T-000-CD02	W4T-000-CB05	W4T-000-1504	W4T-000-1575	WR1-760-4350	11/2010
Ram 2500 (4x4) SRW Mega Cab, w/10.5" axle	10-11		0041	W4T-000-C07S	W4T-000-CL01		W4T-000-CD02	W4T-000-CB05	W4T-000-1504	W4T-000-1575	WR1-760-4350	11/2010
Ram 2500 (4x2 only) Regular and Quad Cab, w/10.5" axle	06-09		0031	W4T-000-C01S	W4T-000-CL01		W4T-000-CD01	W4T-000-CB01	W4T-000-1504	W4T-000-1575	WR1-760-4350	11/2010
Ram 2500 (4x2 only) Mega Cab, w/10.5" axle	06-09		0033	W4T-000-C02S	W4T-000-CL01		W4T-000-CD01	W4T-000-CB01	W4T-000-1504	W4T-000-1575	WR1-760-4350	11/2010
Ram 2500 (4x4 only) Mega Cab, w/10.5" axle	06-09		0034	W4T-000-C02S	W4T-000-CL01		W4T-000-CD02	W4T-000-CB03	W4T-000-1504	W4T-000-1575	WR1-760-4350	11/2010
Ram 2500 (4x4 only) Regular & Quad Cab, 10.5" axle	06-09		0032	W4T-000-C01S	W4T-000-CL01		W4T-000-CD02	W4T-000-CB03	W4T-000-1504	W4T-000-1575	WR1-760-4350	11/2010
Ram 3500 (4x2) SRW Regular and Quad Cab, w/11.5" axle	10-11		0042	W4T-000-C06S	W4T-000-CL01		W4T-000-CD03	W4T-000-CB04	W4T-000-1504	W4T-000-1575	WR1-760-4350	11/2010
Ram 3500 (4x2) SRW Mega Cab, w/11.5" axle	10-11		0043	W4T-000-C07S	W4T-000-CL01		W4T-000-CD03	W4T-000-CB04	W4T-000-1504	W4T-000-1575	WR1-760-4350	11/2010
Ram 3500 (4x2) DRW Regular, Quad and Mega Cab, w/11.5" axle	10-11		0044	W4T-000-C07S	W4T-000-CL01		W4T-000-CD03	W4T-000-CB04	W4T-000-1504	W4T-000-1575	WR1-760-4350	11/2010
Ram 3500 (4x4) SRW Regular and Quad Cab, w/11.5" axle	10-11		0045	W4T-000-C06S	W4T-000-CL01		W4T-000-CD04	W4T-000-CB05	W4T-000-1504	W4T-000-1575	WR1-760-4350	11/2010
Ram 3500 (4x4) SRW Mega Cab, w/11.5" axle	10-11		0046	W4T-000-C07S	W4T-000-CL01		W4T-000-CD04	W4T-000-CB05	W4T-000-1504	W4T-000-1575	WR1-760-4350	11/2010
Ram 3500 (4x4) DRW Regular and Quad Cab, w/11.5" axle	10-11		0047	W4T-000-C08S	W4T-000-CL01		W4T-000-CD04	W4T-000-CB05	W4T-000-1504	W4T-000-1575	WR1-760-4350	11/2010
Ram 3500 (4x4) DRW Mega Cab, w/11.5" axle	10-11		0048	W4T-000-C07S	W4T-000-CL01		W4T-000-CD04	W4T-000-CB05	W4T-000-1504	W4T-000-1575	WR1-760-4350	11/2010
Ram 3500 (4x2 only) SRW, Mega Cab, w/11.5" axle	06-09		0049	W4T-000-C02S	W4T-000-CL01		W4T-000-CD03	W4T-000-CB01	W4T-000-1504	W4T-000-1575	WR1-760-4350	11/2010
Ram 3500 (4x2 only) DRW, Regular,Quad and Mega Cab	06-09		0050	W4T-000-C02S	W4T-000-CL01		W4T-000-CD03	W4T-000-CB01	W4T-000-1504	W4T-000-1575	WR1-760-4350	11/2010
Ram 3500 (4x2 only) SRW Regular & Quad Cab, w/11.5" axle	06-09		0051	W4T-000-C01S	W4T-000-CL01		W4T-000-CD03	W4T-000-CB01	W4T-000-1504	W4T-000-1575	WR1-760-4350	11/2010
Ram 3500 (4x4 only) SRW, Regular & Quad Cab, w/11.5" axle	06-09		0052	W4T-000-C01S	W4T-000-CL01		W4T-000-CD04	W4T-000-CB03	W4T-000-1504	W4T-000-1575	WR1-760-4350	11/2010
Ram 3500 (4x4 only) SRW/DRW, Mega Cab, w/11.5" axle	06-09		0053	W4T-000-C02S	W4T-000-CL01		W4T-000-CD04	W4T-000-CB03	W4T-000-1504	W4T-000-1575	WR1-760-4350	11/2010
Ram 3500 (4x4 only) DRW, Regular & Quad Cab, w/11.5" axle	06-09		0035	W4T-000-C04S	W4T-000-CL01		W4T-000-CD04	W4T-000-CB03	W4T-000-1504	W4T-000-1575	WR1-760-4350	11/2010
Ford Pickup Trucks												
F-250 (4x2) Long Bed, SRW, w/10.5" axle	2011		0054	W4T-000-F02S	W4T-000-FL02		W4T-000-FD20	W4T-000-FB05	W4T-000-1507	W4T-000-1575	WR1-760-4351	12/2010
F-250 (4x4) Long Bed, SRW, w/10.5" axle & 2" block	2011		0055	W4T-000-F02S	W4T-000-FL02		W4T-000-FD19	W4T-000-FB05	W4T-000-1507	W4T-000-1575	WR1-760-4351	12/2010
F-250 (4x4) Short Bed, SRW, w/10.5" axle & 2" block	2011		0056	W4T-000-F02S	W4T-000-FL02		W4T-000-FD19	W4T-000-FB04	W4T-000-1507	W4T-000-1575	WR1-760-4351	12/2010
F-250 (4x2) Long Bed, SRW, w/10.5" axle	08-10		0008	W4T-000-F02S	W4T-000-FL02		W4T-000-FD06	W4T-000-FB02	W4T-000-1502	W4T-000-1575	WR1-760-4351	12/2010
F-250 (4x2) Short Bed, SRW, w/10.5" axle	08-10		0005	W4T-000-F02S	W4T-000-FL02		W4T-000-FD06	W4T-000-FB04	W4T-000-1502	W4T-000-1575	WR1-760-4351	12/2010
F-250 (4x4) Long Bed, SRW, w/10.5" axle & 2" block	08-10		0009	W4T-000-F02S	W4T-000-FL02		W4T-000-FD07	W4T-000-FB02	W4T-000-1502	W4T-000-1575	WR1-760-4351	12/2010
F-250 (4x4) Short Bed, SRW, w/10.5" axle & 2" block	08-10		0006	W4T-000-F02S	W4T-000-FL02		W4T-000-FD07	W4T-000-FB04	W4T-000-1502	W4T-000-1575	WR1-760-4351	12/2010
F-250 (4x4) Long Bed, SRW, w/10.5" axle & 2" block	05-07		0025	W4T-000-F01S	W4T-000-FL01		W4T-000-FD03	W4T-000-FB01	W4T-000-1502	W4T-000-1575	WR1-760-4351	12/2010
F-250 (4x4) Short Bed, SRW, w/10.5" axle & 2" block	05-07		0020	W4T-000-F01S	W4T-000-FL01		W4T-000-FD03	W4T-000-FB03	W4T-000-1502	W4T-000-1575	WR1-760-4351	12/2010
F-250 (4x2) Long Bed,SRW, w/10.5" axle	99-04		0022	W4T-000-F01S	W4T-000-FL01		W4T-000-FD04	W4T-000-FB01	W4T-000-1501	W4T-000-1575	WR1-760-4351	12/2010
F-250 (4x2) Short Bed, SRW, w/10.5" axle	99-04		0017	W4T-000-F01S	W4T-000-FL01		W4T-000-FD04	W4T-000-FB03	W4T-000-1501	W4T-000-1575	WR1-760-4351	12/2010
F-250 (4x4) Long Bed, SRW, w/10.5" axle & 2" block	99-04		0023	W4T-000-F01S	W4T-000-FL01		W4T-000-FD03	W4T-000-FB01	W4T-000-1501	W4T-000-1575	WR1-760-4351	12/2010
F-250 (4x4) Short Bed, SRW, w/10.5" axle & 2" block	99-04		0018	W4T-000-F01S	W4T-000-FL01		W4T-000-FD03	W4T-000-FB03	W4T-000-1501	W4T-000-1575	WR1-760-4351	12/2010

Note: W4T-000-1577, Electronic Leveling Control Kit, can be used in place of W4T-000-1575

Kits and quantity required for kit installation												
Vehicle	Year	Lifted	Master kit	2	1		1	1	1	1	1	Availability Date
			W28-760	Leaf springs	Links	Differential bracket	Frame (eye) bracket	Air spring kit	Air control kit	Load adaptive shocks		
Ford Pickup Trucks Continued												
F-350 (4x2) Long Bed, SRW, w/10.5" axle	2011		0054	W4T-000-F02S	W4T-000-FL02		W4T-000-FD20	W4T-000-FB05	W4T-000-1507	W4T-000-1575	WR1-760-4351	12/2010
F-350 (4x2) Short Bed, SRW, w/10.5" axle	2011		0055	W4T-000-F02S	W4T-000-FL02		W4T-000-FD20	W4T-000-FB04	W4T-000-1507	W4T-000-1575	WR1-760-4351	12/2010
F-350 (4x2) Long Bed, DRW, w/Dana 80 axle	2011		0056	W4T-000-F02S	W4T-000-FL02		W4T-000-FD22	W4T-000-FB05	W4T-000-1507	W4T-000-1575	WR1-760-4351	12/2010
F-350 (4x2) Short Bed, DRW, w/Dana 80 axle	2011		0057	W4T-000-F02S	W4T-000-FL02		W4T-000-FD22	W4T-000-FB04	W4T-000-1507	W4T-000-1575	WR1-760-4351	12/2010
F-350 (4x4) Long Bed, SRW, w/10.5" axle & 2" block	2011		0058	W4T-000-F02S	W4T-000-FL02		W4T-000-FD19	W4T-000-FB05	W4T-000-1507	W4T-000-1575	WR1-760-4354	12/2010
F-350 (4x4) Short Bed, SRW, w/10.5" axle & 2" block	2011		0059	W4T-000-F02S	W4T-000-FL02		W4T-000-FD19	W4T-000-FB04	W4T-000-1507	W4T-000-1575	WR1-760-4354	12/2010
F-350 (4x4) Long Bed, DRW, w/Dana 80 axle & 2" block	2011		0060	W4T-000-F02S	W4T-000-FL02		W4T-000-FD21	W4T-000-FB05	W4T-000-1507	W4T-000-1575	WR1-760-4354	12/2010
F-350 (4x4) Short Bed, DRW, w/Dana 80 axle & 2" block	2011		0061	W4T-000-F02S	W4T-000-FL02		W4T-000-FD21	W4T-000-FB04	W4T-000-1507	W4T-000-1575	WR1-760-4354	12/2010
F-350 (4x2) Long Bed, SRW, w/10.5" axle	08-10		0008	W4T-000-F02S	W4T-000-FL02		W4T-000-FD06	W4T-000-FB02	W4T-000-1502	W4T-000-1575	WR1-760-4351	12/2010
F-350 (4x2) Short Bed, SRW, w/10.5" axle	08-10		0005	W4T-000-F02S	W4T-000-FL02		W4T-000-FD06	W4T-000-FB04	W4T-000-1502	W4T-000-1575	WR1-760-4351	12/2010
F-350 (4x2) Long Bed, DRW, w/Dana 80 axle	08-10		0003	W4T-000-F02S	W4T-000-FL02		W4T-000-FD08	W4T-000-FB02	W4T-000-1502	W4T-000-1575	WR1-760-4351	12/2010
F-350 (4x2) Short Bed, DRW, w/Dana 80 axle	08-10		0001	W4T-000-F02S	W4T-000-FL02		W4T-000-FD08	W4T-000-FB04	W4T-000-1502	W4T-000-1575	WR1-760-4351	12/2010
F-350 (4x4) Long Bed, SRW, w/10.5" axle & 2" block	08-10		0010	W4T-000-F02S	W4T-000-FL02		W4T-000-FD07	W4T-000-FB02	W4T-000-1502	W4T-000-1575	WR1-760-4354	12/2010
F-350 (4x4) Short Bed, SRW, w/10.5" axle & 2" block	08-10		0007	W4T-000-F02S	W4T-000-FL02		W4T-000-FD07	W4T-000-FB04	W4T-000-1502	W4T-000-1575	WR1-760-4354	12/2010
F-350 (4x4) Long Bed, DRW, w/Dana 80 axle & 2" block	08-10		0004	W4T-000-F02S	W4T-000-FL02		W4T-000-FD02	W4T-000-FB02	W4T-000-1502	W4T-000-1575	WR1-760-4354	12/2010
F-350 (4x4) Short Bed, DRW, w/Dana 80 axle & 2" block	08-10		0002	W4T-000-F02S	W4T-000-FL02		W4T-000-FD02	W4T-000-FB04	W4T-000-1502	W4T-000-1575	WR1-760-4354	12/2010
F-350 (4x4) Long Bed, SRW, w/10.5" axle & 2" block	05-07		0026	W4T-000-F01S	W4T-000-FL01		W4T-000-FD03	W4T-000-FB01	W4T-000-1502	W4T-000-1575	WR1-760-4354	12/2010
F-350 (4x4) Short Bed, SRW, w/10.5" axle & 2" block	05-07		0021	W4T-000-F01S	W4T-000-FL01		W4T-000-FD03	W4T-000-FB03	W4T-000-1502	W4T-000-1575	WR1-760-4354	12/2010
F-350 (4x4) Long Bed DRW, w/Dana 80 axle & 2" block	05-07		0016	W4T-000-F01S	W4T-000-FL01		W4T-000-FD01	W4T-000-FB01	W4T-000-1502	W4T-000-1575	WR1-760-4354	12/2010
F-350 (4x4) Short Bed, DRW, w/Dana 80 axle & 2" block	05-07		0013	W4T-000-F01S	W4T-000-FL01		W4T-000-FD01	W4T-000-FB03	W4T-000-1502	W4T-000-1575	WR1-760-4354	12/2010
F-350 (4x2) Long Bed, SRW, w/10.5" axle	99-04		0022	W4T-000-F01S	W4T-000-FL01		W4T-000-FD04	W4T-000-FB01	W4T-000-1501	W4T-000-1575	WR1-760-4351	12/2010
F-350 (4x2) Short Bed, SRW, w/10.5" axle	99-04		0017	W4T-000-F01S	W4T-000-FL01		W4T-000-FD04	W4T-000-FB03	W4T-000-1501	W4T-000-1575	WR1-760-4351	12/2010
F-350 (4x2) Long Bed, DRW, w/Dana 80 axle	99-04		0014	W4T-000-F01S	W4T-000-FL01		W4T-000-FD05	W4T-000-FB01	W4T-000-1501	W4T-000-1575	WR1-760-4351	12/2010
F-350 (4x2) Short Bed, DRW, w/Dana 80 axle	99-04		0011	W4T-000-F01S	W4T-000-FL01		W4T-000-FD05	W4T-000-FB03	W4T-000-1501	W4T-000-1575	WR1-760-4351	12/2010
F-350 (4x4) Long Bed, SRW, w/10.5" axle & 2" block	99-04		0024	W4T-000-F01S	W4T-000-FL01		W4T-000-FD03	W4T-000-FB01	W4T-000-1501	W4T-000-1575	WR1-760-4354	12/2010
F-350 (4x4) Short Bed, SRW, w/10.5" axle & 2" block	99-04		0019	W4T-000-F01S	W4T-000-FL01		W4T-000-FD03	W4T-000-FB03	W4T-000-1501	W4T-000-1575	WR1-760-4354	12/2010
F-350 (4x4) Long Bed, DRW, w/Dana 80 axle & 2" block	99-04		0015	W4T-000-F01S	W4T-000-FL01		W4T-000-FD01	W4T-000-FB01	W4T-000-1501	W4T-000-1575	WR1-760-4354	12/2010
F-350 (4x4) Short Bed, DRW, w/Dana 80 axle & 2" block	99-04		0012	W4T-000-F01S	W4T-000-FL01		W4T-000-FD01	W4T-000-FB03	W4T-000-1501	W4T-000-1575	WR1-760-4354	12/2010
3-4" Front Lift Range Corresponding Rear Kits												
Chevrolet/GMC Pickup Trucks												
2500 (4x4) Long Bed, w/10.5" axle	05-10	4"	0062	W4T-000-G01S	W4T-000-GL01		W4T-000-GD06	W4T-000-GB02	W4T-000-1508	W4T-000-1575	W4T-000-4358	2/2011
2500 (4x4) Short Bed, w/10.5" axle	05-10	4"	0063	W4T-000-G01S	W4T-000-GL01		W4T-000-GD06	W4T-000-GB01	W4T-000-1508	W4T-000-1575	W4T-000-4358	2/2011
3500 (4x4) Long Bed, SRW/DRW, w/11.5" axle	05-10	4"	0064	W4T-000-G02S	W4T-000-GL01		W4T-000-GD07	W4T-000-GB02	W4T-000-1508	W4T-000-1575	W4T-000-4358	2/2011
3500 (4x4) Short Bed SRW/DRW, w/11.5" axle	05-10	4"	0065	W4T-000-G02S	W4T-000-GL01		W4T-000-GD07	W4T-000-GB01	W4T-000-1508	W4T-000-1575	W4T-000-4358	2/2011
Dodge Pickup Trucks												
Ram 2500 (4x4) SRW Regular and Quad Cab, w/10.5" axle	10-11	3"	0066	W4T-000-C06S	W4T-000-CL01		W4T-000-CD05	W4T-000-CB05	W4T-000-1509	W4T-000-1575	W4T-000-4359	2/2011
Ram 2500 (4x4) SRW Mega Cab, w/10.5" axle	10-11	3"	0067	W4T-000-C07S	W4T-000-CL01		W4T-000-CD05	W4T-000-CB05	W4T-000-1509	W4T-000-1575	W4T-000-4359	2/2011
Ram 2500 (4x4 only) Mega Cab 10.5" axle	06-09	3"	0068	W4T-000-C02S	W4T-000-CL01		W4T-000-CD05	W4T-000-CB03	W4T-000-1509	W4T-000-1575	W4T-000-4359	2/2011
Ram 2500 (4x4 only) Regular & Quad Cab, 10.5" axle	06-09	3"	0069	W4T-000-C01S	W4T-000-CL01		W4T-000-CD05	W4T-000-CB03	W4T-000-1509	W4T-000-1575	W4T-000-4359	2/2011
Ram 3500 (4x4) SRW Regular and Quad Cab, w/11.5" axle	10-11	3"	0070	W4T-000-C06S	W4T-000-CL01		W4T-000-CD06	W4T-000-CB05	W4T-000-1509	W4T-000-1575	W4T-000-4359	2/2011
Ram 3500 (4x4) SRW Mega Cab, w/11.5" axle	10-11	3"	0071	W4T-000-C07S	W4T-000-CL01		W4T-000-CD06	W4T-000-CB05	W4T-000-1509	W4T-000-1575	W4T-000-4359	2/2011
Ram 3500 (4x4) DRW Regular and Quad Cab, w/11.5" axle	10-11	3"	0072	W4T-000-C08S	W4T-000-CL01		W4T-000-CD06	W4T-000-CB05	W4T-000-1509	W4T-000-1575	W4T-000-4359	2/2011

Note: W4T-000-1577, Electronic Leveling Control Kit, can be used in place of W4T-000-1575

Kits and quantity required for kit installation												
Vehicle	Year	Lifted	Master kit W28-760	2 Leaf springs	1 Links		1 Differential bracket	1 Frame (eye) bracket	1 Air spring kit	1 Air control kit	1 Load adaptive shocks	Availability Date
Dodge Pickup Trucks Continued												
Ram 3500 (4x4) DRW Mega Cab, w/11.5" axle	10-11	3"	0073	W4T-000-C07S	W4T-000-CL01		W4T-000-CD06	W4T-000-CB05	W4T-000-1509	W4T-000-1575	W4T-000-4359	2/2011
Ram 3500 (4x4 only) SRW, Regular & Quad Cab, 11.5" axle	06-09	3"	0074	W4T-000-C01S	W4T-000-CL01		W4T-000-CD06	W4T-000-CB03	W4T-000-1509	W4T-000-1575	W4T-000-4359	2/2011
Ram 3500 (4x4 only) SRW/DRW, Mega Cab, 11.5" axle	06-09	3"	0075	W4T-000-C02S	W4T-000-CL01		W4T-000-CD06	W4T-000-CB03	W4T-000-1509	W4T-000-1575	W4T-000-4359	2/2011
Ram 3500 (4x4 only) DRW, Regular & Quad Cab 11.5" axle	06-09	3"	0076	W4T-000-C04S	W4T-000-CL01		W4T-000-CD06	W4T-000-CB03	W4T-000-1509	W4T-000-1575	W4T-000-4359	2/2011
Ford Pickup Trucks												
F-250 (4x4) Long Bed, SRW, w/10.5" axle & 2" block	2011	4"	0077	W4T-000-F02S	W4T-000-FL02		W4T-000-FD23	W4T-000-FB05	W4T-000-1510	W4T-000-1575	W4T-000-4360	2/2011
F-250 (4x4) Short Bed, SRW, w/10.5" axle & 2" block	2011	4"	0078	W4T-000-F02S	W4T-000-FL02		W4T-000-FD23	W4T-000-FB04	W4T-000-1510	W4T-000-1575	W4T-000-4360	2/2011
F-250 (4x4) Long Bed, SRW, w/10.5" axle & 2" block	08-10	4"	0079	W4T-000-F02S	W4T-000-FL02		W4T-000-FD10	W4T-000-FB02	W4T-000-1511	W4T-000-1575	W4T-000-4360	2/2011
F-250 (4x4) Short Bed, SRW, w/10.5" axle & 2" block	08-10	4"	0080	W4T-000-F02S	W4T-000-FL02		W4T-000-FD10	W4T-000-FB04	W4T-000-1511	W4T-000-1575	W4T-000-4360	2/2011
F-250 (4x4) Long Bed, SRW, w/10.5" axle & 2" block	05-07	4"	0081	W4T-000-F01S	W4T-000-FL01		W4T-000-FD12	W4T-000-FB01	W4T-000-1511	W4T-000-1575	W4T-000-4360	2/2011
F-250 (4x4) Short Bed, SRW, w/10.5" axle & 2" block	05-07	4"	0082	W4T-000-F01S	W4T-000-FL01		W4T-000-FD12	W4T-000-FB03	W4T-000-1511	W4T-000-1575	W4T-000-4360	2/2011
F-250 (4x4) Long Bed, SRW, w/10.5" axle & 2" block	99-04	4"	0083	W4T-000-F01S	W4T-000-FL01		W4T-000-FD12	W4T-000-FB01	W4T-000-1512	W4T-000-1575	W4T-000-4360	2/2011
F-250 (4x4) Short Bed, SRW, w/10.5" axle & 2" block	99-04	4"	0084	W4T-000-F01S	W4T-000-FL01		W4T-000-FD12	W4T-000-FB03	W4T-000-1512	W4T-000-1575	W4T-000-4360	2/2011
F-350 (4x4) Long Bed, SRW, w/10.5" axle & 2" block	2011	4"	0085	W4T-000-F02S	W4T-000-FL02		W4T-000-FD23	W4T-000-FB05	W4T-000-1510	W4T-000-1575	W4T-000-4360	2/2011
F-350 (4x4) Short Bed, SRW, w/10.5" axle & 2" block	2011	4"	0086	W4T-000-F02S	W4T-000-FL02		W4T-000-FD23	W4T-000-FB04	W4T-000-1510	W4T-000-1575	W4T-000-4360	2/2011
F-350 (4x4) Long Bed, DRW, w/Dana 80 axle & 2" block	2011	4"	0087	W4T-000-F02S	W4T-000-FL02		W4T-000-FD24	W4T-000-FB05	W4T-000-1510	W4T-000-1575	W4T-000-4360	2/2011
F-350 (4x4) Short Bed, DRW, w/Dana 80 axle & 2" block	2011	4"	0088	W4T-000-F02S	W4T-000-FL02		W4T-000-FD24	W4T-000-FB04	W4T-000-1510	W4T-000-1575	W4T-000-4360	2/2011
F-350 (4x4) Long Bed, SRW, w/10.5" axle & 2" block	08-10	4"	0089	W4T-000-F02S	W4T-000-FL02		W4T-000-FD10	W4T-000-FB02	W4T-000-1511	W4T-000-1575	W4T-000-4360	2/2011
F-350 (4x4) Short Bed, SRW, w/10.5" axle & 2" block	08-10	4"	0090	W4T-000-F02S	W4T-000-FL02		W4T-000-FD10	W4T-000-FB04	W4T-000-1511	W4T-000-1575	W4T-000-4360	2/2011
F-350 (4x4) Long Bed, DRW, w/Dana 80 axle & 2" block	08-10	4"	0091	W4T-000-F02S	W4T-000-FL02		W4T-000-FD09	W4T-000-FB02	W4T-000-1511	W4T-000-1575	W4T-000-4360	2/2011
F-350 (4x4) Short Bed, DRW, w/Dana 80 axle & 2" block	08-10	4"	0092	W4T-000-F02S	W4T-000-FL02		W4T-000-FD09	W4T-000-FB04	W4T-000-1511	W4T-000-1575	W4T-000-4360	2/2011
F-350 (4x4) Long Bed, SRW, w/10.5" axle & 2" block	05-07	4"	0093	W4T-000-F01S	W4T-000-FL01		W4T-000-FD12	W4T-000-FB01	W4T-000-1511	W4T-000-1575	W4T-000-4360	2/2011
F-350 (4x4) Short Bed, SRW, w/10.5" axle & 2" block	05-07	4"	0094	W4T-000-F01S	W4T-000-FL01		W4T-000-FD12	W4T-000-FB03	W4T-000-1511	W4T-000-1575	W4T-000-4360	2/2011
F-350 (4x4) Long Bed DRW, w/Dana 80 axle & 2" block	05-07	4"	0095	W4T-000-F01S	W4T-000-FL01		W4T-000-FD11	W4T-000-FB01	W4T-000-1511	W4T-000-1575	W4T-000-4360	2/2011
F-350 (4x4) Short Bed, DRW, w/Dana 80 axle & 2" block	05-07	4"	0096	W4T-000-F01S	W4T-000-FL01		W4T-000-FD11	W4T-000-FB03	W4T-000-1511	W4T-000-1575	W4T-000-4360	2/2011
F-350 (4x4) Long Bed, SRW, w/10.5" axle & 2" block	99-04	4"	0097	W4T-000-F01S	W4T-000-FL01		W4T-000-FD12	W4T-000-FB01	W4T-000-1512	W4T-000-1575	W4T-000-4360	2/2011
F-350 (4x4) Short Bed, SRW, w/10.5" axle & 2" block	99-04	4"	0098	W4T-000-F01S	W4T-000-FL01		W4T-000-FD12	W4T-000-FB03	W4T-000-1512	W4T-000-1575	W4T-000-4360	2/2011
F-350 (4x4) Long Bed, DRW, w/Dana 80 axle & 2" block	99-04	4"	0099	W4T-000-F01S	W4T-000-FL01		W4T-000-FD11	W4T-000-FB01	W4T-000-1512	W4T-000-1575	W4T-000-4360	2/2011
F-350 (4x4) Short Bed, DRW, w/Dana 80 axle & 2" block	99-04	4"	0100	W4T-000-F01S	W4T-000-FL01		W4T-000-FD11	W4T-000-FB03	W4T-000-1512	W4T-000-1575	W4T-000-4360	2/2011
5-6" Front Lift Range Corresponding Rear Kits												
Chevrolet/GMC Pickup Trucks												
2500 (4x4) Long Bed, w/10.5" axle	05-10	6"	0101	W4T-000-G01S	W4T-000-GL01		W4T-000-GD08	W4T-000-GB02	W4T-000-1513	W4T-000-1575	W4T-000-4361	2/2011
2500 (4x4) Short Bed, w/10.5" axle	05-10	6"	0102	W4T-000-G01S	W4T-000-GL01		W4T-000-GD08	W4T-000-GB01	W4T-000-1513	W4T-000-1575	W4T-000-4361	2/2011
3500 (4x4) Long Bed, SRW/DRW, w/11.5" axle	05-10	6"	0103	W4T-000-G02S	W4T-000-GL01		W4T-000-GD09	W4T-000-GB02	W4T-000-1513	W4T-000-1575	W4T-000-4361	2/2011
3500 (4x4) Short Bed SRW/DRW, w/11.5" axle	05-10	6"	0104	W4T-000-G02S	W4T-000-GL01		W4T-000-GD09	W4T-000-GB01	W4T-000-1513	W4T-000-1575	W4T-000-4361	2/2011
Dodge Pickup Trucks												
Ram 2500 (4x4) SRW Regular and Quad Cab, w/10.5" axle	10-11	5"	0105	W4T-000-C06S	W4T-000-CL01		W4T-000-CD07	W4T-000-CB05	W4T-000-1514	W4T-000-1575	W4T-000-4362	2/2011
Ram 2500 (4x4) SRW Mega Cab, w/10.5" axle	10-11	5"	0106	W4T-000-C07S	W4T-000-CL01		W4T-000-CD07	W4T-000-CB05	W4T-000-1514	W4T-000-1575	W4T-000-4362	2/2011
Ram 2500 (4x4 only) Mega Cab 10.5" axle	06-09	5"	0107	W4T-000-C02S	W4T-000-CL01		W4T-000-CD07	W4T-000-CB03	W4T-000-1514	W4T-000-1575	W4T-000-4362	2/2011
Ram 2500 (4x4 only) Regular & Quad Cab, 10.5" axle	06-09	5"	0108	W4T-000-C01S	W4T-000-CL01		W4T-000-CD07	W4T-000-CB03	W4T-000-1514	W4T-000-1575	W4T-000-4362	2/2011
Ram 3500 (4x4) SRW Regular and Quad Cab, w/11.5" axle	10-11	5"	0109	W4T-000-C06S	W4T-000-CL01		W4T-000-CD08	W4T-000-CB05	W4T-000-1514	W4T-000-1575	W4T-000-4362	2/2011
Ram 3500 (4x4) SRW Mega Cab, w/11.5" axle	10-11	5"	0110	W4T-000-C07S	W4T-000-CL01		W4T-000-CD08	W4T-000-CB05	W4T-000-1514	W4T-000-1575	W4T-000-4362	2/2011

Note: W4T-000-1577, Electronic Leveling Control Kit, can be used in place of W4T-000-1575

Kits and quantity required for kit installation												
Vehicle	Year	Lifted	Master kit	2	1		1	1	1	1	1	1
			W28-760	Leaf springs	Links	Differential bracket	Frame (eye) bracket	Air spring kit	Air control kit	Load adaptive shocks	Availability Date	
Dodge Pickup Trucks Continued												
Ram 3500 (4x4) DRW Regular and Quad Cab, w/11.5" axle	10-11	5"	0111	W4T-000-C08S	W4T-000-CL01		W4T-000-CD08	W4T-000-CB05	W4T-000-1514	W4T-000-1575	W4T-000-4362	2/2011
Ram 3500 (4x4) DRW Mega Cab, w/11.5" axle	10-11	5"	0112	W4T-000-C07S	W4T-000-CL01		W4T-000-CD08	W4T-000-CB05	W4T-000-1514	W4T-000-1575	W4T-000-4362	2/2011
Ram 3500 (4x4 only) SRW, Regular & Quad Cab, 11.5" axle	06-09	5"	0113	W4T-000-C01S	W4T-000-CL01		W4T-000-CD08	W4T-000-CB03	W4T-000-1514	W4T-000-1575	W4T-000-4362	2/2011
Ram 3500 (4x4 only) SRW/DRW, Mega Cab, 11.5" axle	06-09	5"	0114	W4T-000-C02S	W4T-000-CL01		W4T-000-CD08	W4T-000-CB03	W4T-000-1514	W4T-000-1575	W4T-000-4362	2/2011
Ram 3500 (4x4 only) DRW, Regular & Quad Cab 11.5" axle	06-09	5"	0115	W4T-000-C04S	W4T-000-CL01		W4T-000-CD08	W4T-000-CB03	W4T-000-1514	W4T-000-1575	W4T-000-4362	2/2011
Ford Pickup Trucks												
F-250 (4x4) Long Bed, SRW, w/10.5" axle & 2" block	2011	6"	0116	W4T-000-F02S	W4T-000-FL02		W4T-000-FD25	W4T-000-FB05	W4T-000-1515	W4T-000-1575	W4T-000-4363	2/2011
F-250 (4x4) Short Bed, SRW, w/10.5" axle & 2" block	2011	6"	0117	W4T-000-F02S	W4T-000-FL02		W4T-000-FD25	W4T-000-FB04	W4T-000-1515	W4T-000-1575	W4T-000-4363	2/2011
F-250 (4x4) Long Bed, SRW, w/10.5" axle & 2" block	08-10	6"	0118	W4T-000-F02S	W4T-000-FL02		W4T-000-FD14	W4T-000-FB02	W4T-000-1516	W4T-000-1575	W4T-000-4363	2/2011
F-250 (4x4) Short Bed, SRW, w/10.5" axle & 2" block	08-10	6"	0119	W4T-000-F02S	W4T-000-FL02		W4T-000-FD14	W4T-000-FB04	W4T-000-1516	W4T-000-1575	W4T-000-4363	2/2011
F-250 (4x4) Long Bed, SRW, w/10.5" axle & 2" block	05-07	6"	0120	W4T-000-F01S	W4T-000-FL01		W4T-000-FD16	W4T-000-FB01	W4T-000-1516	W4T-000-1575	W4T-000-4363	2/2011
F-250 (4x4) Short Bed, SRW, w/10.5" axle & 2" block	05-07	6"	0121	W4T-000-F01S	W4T-000-FL01		W4T-000-FD16	W4T-000-FB03	W4T-000-1516	W4T-000-1575	W4T-000-4363	2/2011
F-250 (4x4) Long Bed, SRW, w/10.5" axle & 2" block	99-04	6"	0122	W4T-000-F01S	W4T-000-FL01		W4T-000-FD16	W4T-000-FB01	W4T-000-1517	W4T-000-1575	W4T-000-4363	2/2011
F-250 (4x4) Short Bed, SRW, w/10.5" axle & 2" block	99-04	6"	0123	W4T-000-F01S	W4T-000-FL01		W4T-000-FD16	W4T-000-FB03	W4T-000-1517	W4T-000-1575	W4T-000-4363	2/2011
F-350 (4x4) Long Bed, SRW, w/10.5" axle & 2" block	2011	6"	0124	W4T-000-F02S	W4T-000-FL02		W4T-000-FD25	W4T-000-FB05	W4T-000-1515	W4T-000-1575	W4T-000-4363	2/2011
F-350 (4x4) Short Bed, SRW, w/10.5" axle & 2" block	2011	6"	0125	W4T-000-F02S	W4T-000-FL02		W4T-000-FD25	W4T-000-FB04	W4T-000-1515	W4T-000-1575	W4T-000-4363	2/2011
F-350 (4x4) Long Bed, DRW, w/Dana 80 axle & 2" block	2011	6"	0126	W4T-000-F02S	W4T-000-FL02		W4T-000-FD26	W4T-000-FB05	W4T-000-1515	W4T-000-1575	W4T-000-4363	2/2011
F-350 (4x4) Short Bed, DRW, w/Dana 80 axle & 2" block	2011	6"	0127	W4T-000-F02S	W4T-000-FL02		W4T-000-FD26	W4T-000-FB04	W4T-000-1515	W4T-000-1575	W4T-000-4363	2/2011
F-350 (4x4) Long Bed, SRW, w/10.5" axle & 2" block	08-10	6"	0128	W4T-000-F02S	W4T-000-FL02		W4T-000-FD14	W4T-000-FB02	W4T-000-1516	W4T-000-1575	W4T-000-4363	2/2011
F-350 (4x4) Short Bed, SRW, w/10.5" axle & 2" block	08-10	6"	0129	W4T-000-F02S	W4T-000-FL02		W4T-000-FD14	W4T-000-FB04	W4T-000-1516	W4T-000-1575	W4T-000-4363	2/2011
F-350 (4x4) Long Bed, DRW, w/Dana 80 axle & 2" block	08-10	6"	0130	W4T-000-F02S	W4T-000-FL02		W4T-000-FD13	W4T-000-FB02	W4T-000-1516	W4T-000-1575	W4T-000-4363	2/2011
F-350 (4x4) Short Bed, DRW, w/Dana 80 axle & 2" block	08-10	6"	0131	W4T-000-F02S	W4T-000-FL02		W4T-000-FD13	W4T-000-FB04	W4T-000-1516	W4T-000-1575	W4T-000-4363	2/2011
F-350 (4x4) Long Bed, SRW, w/10.5" axle & 2" block	05-07	6"	0132	W4T-000-F01S	W4T-000-FL01		W4T-000-FD16	W4T-000-FB01	W4T-000-1516	W4T-000-1575	W4T-000-4363	2/2011
F-350 (4x4) Short Bed, SRW, w/10.5" axle & 2" block	05-07	6"	0133	W4T-000-F01S	W4T-000-FL01		W4T-000-FD16	W4T-000-FB03	W4T-000-1516	W4T-000-1575	W4T-000-4363	2/2011
F-350 (4x4) Long Bed DRW, w/Dana 80 axle & 2" block	05-07	6"	0134	W4T-000-F01S	W4T-000-FL01		W4T-000-FD15	W4T-000-FB01	W4T-000-1516	W4T-000-1575	W4T-000-4363	2/2011
F-350 (4x4) Short Bed, DRW, w/Dana 80 axle & 2" block	05-07	6"	0135	W4T-000-F01S	W4T-000-FL01		W4T-000-FD15	W4T-000-FB03	W4T-000-1516	W4T-000-1575	W4T-000-4363	2/2011
F-350 (4x4) Long Bed, SRW, w/10.5" axle & 2" block	99-04	6"	0136	W4T-000-F01S	W4T-000-FL01		W4T-000-FD16	W4T-000-FB01	W4T-000-1517	W4T-000-1575	W4T-000-4363	2/2011
F-350 (4x4) Short Bed, SRW, w/10.5" axle & 2" block	99-04	6"	0137	W4T-000-F01S	W4T-000-FL01		W4T-000-FD16	W4T-000-FB03	W4T-000-1517	W4T-000-1575	W4T-000-4363	2/2011
F-350 (4x4) Long Bed, DRW, w/Dana 80 axle & 2" block	99-04	6"	0138	W4T-000-F01S	W4T-000-FL01		W4T-000-FD15	W4T-000-FB01	W4T-000-1517	W4T-000-1575	W4T-000-4363	2/2011
F-350 (4x4) Short Bed, DRW, w/Dana 80 axle & 2" block	99-04	6"	0139	W4T-000-F01S	W4T-000-FL01		W4T-000-FD15	W4T-000-FB03	W4T-000-1517	W4T-000-1575	W4T-000-4363	2/2011

Note: W4T-000-1577, Electronic Leveling Control Kit, can be used in place of W4T-000-1575

MAKE	MODEL	YEAR	FRONT/ REAR KIT
1003 - replacement spring 7210			
Chevrolet	Suburban 2500 (4x2, 4x4)	00-09	Front
Chevrolet/GMC	C-1500 HD Silverado, Sierra (4x2, 4x4)	05-06	Front
Chevrolet/GMC	C-1500 HD Silverado, Sierra (4x2, 4x4)	01-03	Front
Chevrolet/GMC	C-2500 HD, C-3500 HD (4x2, 4x4)	01-10	Front
Chevrolet/GMC	C-3500 HD, Silverado, Sierra (4x2, 4x4)	01-10	Front
GMC	Denali XL 2500 (4x2, 4x4)	00-09	Front
GMC	Yukon XL 2500 (4x2, 4x4)	00-09	Front
1004 - replacement spring 7215			
Dodge	Ram 2500 (4x4 only)	03-11	Front
Dodge	Ram 3500 (4x4 only)	03-11	Front
1005 - replacement spring 7217			
Chrysler	Town and Country	96-07	Rear
Dodge	Caravan, Grand Caravan	96-07	Rear
2025 - replacement spring 6781			
Chevrolet/GMC	C & K-1500 (4x2, 4x4)	88-98	Rear
Chevrolet/GMC	C & K-2500 (4x2, 4x4) (with rear drum brakes)	99-00	Rear
Chevrolet/GMC	C & K-2500 (4x2, 4x4)	88-98	Rear
Chevrolet/GMC	C & K-3500 (4x2, 4x4)	88-00	Rear
2061 - replacement spring 6764			
Ford	E-250	07-08	Rear
Ford	E33 (with front coil springs)	92-96	Rear
Ford	E-350 (with dual rear wheels)	92-10	Rear
2071 - replacement spring 6781			
Chevrolet/GMC	C & R 10, 1500 (4x2 only)	73-87	Rear
Chevrolet/GMC	C & R-20 (4x2 only)	73-87	Rear
Chevrolet/GMC	C & R-30, C & R-3500 (4x2 only)	73-87	Rear
Dodge	D & W 100, 150, Ram 1500 (4x2, 4x4)	69-01	Rear
Dodge	D & W 200, 250, Ram 2500 (4x2, 4x4)	69-02	Rear
Dodge	D & W 300, 350, Ram 3500 (4x2, 4x4)	69-02	Rear
Ford	F-100, 150 (4x2, 4x4)	69-96	Rear
Ford	F-250 under 8500 GVWR (4x2, 4x4)	69-96	Rear
Ford	F-250 (4x2, 4x4) (without factory inbed hitch)	11	Rear
Ford	F-250 over 8500 GVWR (4x2, 4x4)	63-10	Rear
Ford	F-350 (4x2, 4x4) (without factory inbed hitch)	11	Rear
2101 - replacement spring 6781			
Cadillac	Escalade (4X2, 4X4) (4 door only)	99-00	Rear
Chevrolet	Suburban 1500 (4x2, 4x4)	92-99	Rear
Chevrolet	Suburban 2500 (4x2, 4x4)	92-99	Rear
Chevrolet	Tahoe (4x2, 4x4) (4-door only)	95-99	Rear
GMC	Yukon 1500 (4x2, 4x4) (4-door only)	95-99	Rear
2170 - replacement spring 6781			
Ford	F53 (16,000 to 22,000 GVWR) (not Thor m/h)	08-10	Rear
Ford	F53 (16,000, 18,000 GVWR) (not Thor m/h)	99-07	Rear
Ford	F59	11	Rear

MAKE	MODEL	YEAR	FRONT/ REAR KIT
2172 - replacement spring 9001			
Ford	Ranger (4x2, 4x4) (not for use with composite leaf) (not SuperCab 4x4 with 6' bed)	83-09	Rear
2190 - replacement spring 6781			
Chevrolet/GMC	C-1500 HD Silverado, Sierra (4x2, 4x4)	05-06	Rear
Chevrolet/GMC	C-1500 HD Silverado, Sierra (4x2, 4x4)	01-03	Rear
Chevrolet/GMC	C-2500, Silverado, Sierra (4x2, 4x4) (not HD)	99-05	Rear
2245 - replacement spring 6781			
Toyota	Tundra (4x4 only)	00-06	Rear
Toyota	Tundra TRD (4x2 only)	00-06	Rear
2249 - replacement spring 6781			
Chevrolet/GMC	C-2500 HD, C-3500 HD (4x2, 4x4), cab & chassis	01-10	Rear
2250 - replacement spring 6781			
Chevrolet/GMC	C-2500 HD, Silverado, Sierra (4x2 4x4)	01-10	Rear
Chevrolet/GMC	C-3500 HD, Silverado, Sierra (4x2, 4x4)	01-10	Rear
2251 - replacement spring 6781			
Ford	Excursion (4x4 only)	00-06	Rear
2286 - replacement spring 6781			
Dodge	Ram 1500 (4x2, 4x4)	02-08	Rear
2299 - replacement spring 6401			
Dodge	Ram 1500 Mega Cab (4x2, 4x4)	06-08	Rear
Dodge	Ram 2500 (4x2, 4x4)	03-11	Rear
Dodge	Ram 3500 (4x2, 4x4)	03-11	Rear
2320 - replacement spring 9000			
Chevrolet/GMC	C & K-1500, Silverado Classic, Sierra Classic (4x2, 4x4)	07	Rear
Chevrolet/GMC	C & K-1500, Silverado, Sierra (4x2, 4x4) (not HD)	99-06	Rear
Ford	F-150 Heritage (4x2, 4x4)	04	Rear
Ford	F-150 (4x2, 4x4)	97-03	Rear
Ford	F-250 under 8500 GVWR (4x2, 4x4)	97-03	Rear
2330 - replacement spring 6401			
Ford	F-250 over 8500 GVWR (4x2, 4x4)	99-04	Rear
Ford	F-350 (4x2, 4x4)	99-04	Rear
2350 - replacement spring 3697			
Ford	F-150 (4x2, 4x4) (not FX2)	04-08	Rear
Lincoln	Mark LT (4x2, 4x4)	05-08	Rear
2355 - replacement spring 6781			
Nissan	Titan (4x2, 4x4)	04-10	Rear
2400 - replacement spring 6401			
Ford	F-250 (4x4 only)	05-07	Rear
Ford	F-350 (4x4 only)	05-07	Rear
2404 - replacement spring 7325			
Dodge	Ram 4500, 5500 (4x2, 4x4) (requires 2" clearance above frame)	07-11	Rear
Ford	F-550 (4x2, 4x4) (requires 2" clearance above frame)	99-11	Rear

MAKE	MODEL	YEAR	FRONT/ REAR KIT
2407 - replacement spring 6766			
Toyota	Tacoma (4x4 only)	05-11	Rear
Toyota	Tacoma TRD Prerunner (4x2 only)	05-11	Rear
2430 - replacement spring 6397			
Chevrolet/GMC	C & K-1500 Silverado, Sierra (4x2, 4x4)	07-11	Rear
2445 - replacement spring 6410			
Toyota	Tundra (4x2, 4x4)	07-11	Rear
2450 - replacement spring 6401			
Ford	F-250 (4x2, 4x4) (gasoline) (without factory inbed hitch)	11	Rear
Ford	F-250 (4x2, 4x4)	08-10	Rear
Ford	F-350 (4x2, 4x4) (gasoline) (without factory inbed hitch)	11	Rear
Ford	F-350 (4x2, 4x4)	08-10	Rear
2452 - replacement spring 6781			
Ford	F-250 (4x2, 4x4) (gasoline) (without factory inbed hitch)	11	Rear
Ford	F-250 (4x2, 4x4)	08-10	Rear
Ford	F-350 (4x2, 4x4) (gasoline) (without factory inbed hitch)	11	Rear
Ford	F-350 (4x2, 4x4)	08-10	Rear
2525 - replacement spring 6781			
Ford	F-150 (4x2, 4x4)	09-11	Rear
Lincoln	Mark LT (4x2, 4x4)	09	Rear
4100 - replacement spring 6000			
Chevrolet	Blazer (4x2 only) (full size)	73-91	Front
Chevrolet/GMC	C & R 10, 1500 (4x2 only)	73-87	Front
Chevrolet/GMC	C & R-20 (4x2 only)	73-87	Front
Chevrolet/GMC	C-30 (4X2 only)	67-87	Front
Chevrolet/GMC	G-10, G-20, G-30, G-1500, G-2500, G-3500	70-95	Front
Chevrolet/GMC	GP-30 HD (cutaway) (14,500 GVWR)	93-96	Front
Chevrolet/GMC	P-30	93-99	Front
Chevrolet/GMC	Suburban 1500, 2500 (4x2 only)	73-91	Front
GMC	Jimmy (4x2 only) (full size)	73-91	Front
4101 - replacement spring 6002			
Ford	E-150	75-11	Front
Ford	E-250	75-11	Front
Ford	E-350	75-11	Front
Ford	E-450	96-11	Front
Ford	F-250 under 8500 GVWR (4x2 only)	69-96	Front
Ford	F-250 over 8500 GVWR (4x2 only)	84-11	Front
Ford	F-350 (4x2 only)	06-11	Front
Ford	F-350 (4x2 only)	70-04	Front
Ford	F-450 (4x2 only)	08-11	Front
Ford	E33 (with front coil springs)	86-91	Front
Ford	E33 (with front coil springs)	92-96	Front
4106 - replacement spring 6015			
Buick	Riviera	79-85	Rear
Cadillac	El Dorado	79-85	Rear

MAKE	MODEL	YEAR	FRONT/ REAR KIT
4106 - replacement spring 6015 Continued			
Cadillac	Seville	80-85	Rear
Ford	Thunderbird	80-88	Rear
Ford	Windstar	98-03	Rear
Isuzu	Trooper	92-97	Rear
Lincoln	Continental (with rear coil springs)	82-88	Rear
Lincoln	Mark IV (with rear coil springs)	84-87	Rear
Mercury	Cougar	80-88	Rear
Nissan	Pathfinder (4x2, 4x4)	87-95	Rear
Oldsmobile	Bravada (4x2, 4x4) (with rear coil springs)	02-05	Rear
Oldsmobile	Toronado	79-85	Rear
4108 - replacement spring 6003			
Cadillac	Escalade, ESV, EXT (4X2, 4X4)	02-10	Rear
Chevrolet	Avalanche 1500 (4x2, 4x4)	02-10	Rear
Chevrolet	Suburban 1500 (4x2, 4x4)	00-10	Rear
Chevrolet	Tahoe (4x2, 4x4)	00-10	Rear
Chevrolet	Trailblazer (4x2, 4x4)	02-09	Rear
Ford	Country Squire	83-97	Rear
Ford	Crown Victoria	83-97	Rear
GMC	Envoy (4x2, 4x4) (with rear coil springs)	02-09	Rear
GMC	Yukon 1500 (4x2, 4x4)	00-10	Rear
Hummer	H2, H2 SUT (with rear coil springs)	03-09	Rear
Lincoln	Towncar	80-89	Rear
Mercury	Colony Park	83-97	Rear
Mercury	Grand Marquis	83-97	Rear
4118 - replacement spring 4118			
Infiniti	FX45 (4x2, 4x4)	03-08	Rear
Jeep	Grand Cherokee (4x2, 4x4) (not "up country")	92-98	Rear
Jeep	Grand Wagoneer (2x4, 4x4)	92-98	Rear
Nissan	Murano (4x2, 4x4)	03-08	Rear
Nissan	Quest	04-09	Rear
Toyota	ECHO	01-05	Rear
Toyota	Siena	98-03	Rear
4134 - replacement spring 6022			
Ford	Expedition (4x2, 4x4) (with rear coil springs)	97-02	Rear
4135 - replacement spring 6024			
Toyota	4Runner	98-10	Rear
4138 - replacement spring 6017			
Honda	Odyssey	99-04	Rear
Honda	Pilot	01-04	Rear
Hyundai	Entourage	07-09	Rear
Kia	Sodona	06-08	Rear

MAKE	MODEL	YEAR	FRONT/ REAR KIT
4155 - replacement spring 6020			
Buick	Terraza	05-07	Rear
Chevrolet	Uplander	05-09	Rear
Saturn	Relay	05-07	Rear
Toyota	Siena	04-10	Rear
4160 - replacement spring 6025			
Ford	F-250 (4x4 only)	05-10	Front
Ford	F-350 (4x2 only)	05-08	Front
Ford	F-350 (4x4 only)	05-10	Front
Ford	F-450 (4x2, 4x4)	05-10	Front
Ford	F-550 (4x2, 4x4) (requires 2" clearance above frame)	05-10	Front
4185 - replacement spring 6025			
Dodge/Ram	Ram 1500 (4x2, 4x4)	09-11	Rear
8602 - replacement spring 1259			
Chevrolet/GMC	C-2500 HD, Silverado, Sierra (4x2 only)	01-10	Rear
8604 - replacement spring 1259			
Chevrolet/GMC	C-2500 HD, Silverado, Sierra (4x4 only)	01-10	Rear
8605 - replacement spring 1258			
Chevrolet/GMC	1500 Silverado, Sierra (4x2, 4x4) (not HD)	99-11	Rear
8606 - replacement spring 1258			
Ford	F-150 (4x2, 4x4)	04-11	Rear
8608 - replacement spring 1259			
Dodge/Ram	Ram 2500 (4x2 4x4)	03-11	Rear
8611 - replacement spring 1260			
Dodge/Ram	Ram 3500 (4x2, 4x4)	03-11	Rear
Dodge/Ram	Ram 3500 (4x2, 4x4) (cab & chassis)	07-11	Rear
8612 - replacement spring 1259			
Ford	F-250 (4x2, 4x4)	99-04	Rear
8613 - replacement spring 1260			
Ford	F-350 (4x2, 4x4)	99-04	Rear
8614 - replacement spring 1259			
Ford	F-250 (4x2, 4x4)	05-11	Rear
8615 - replacement spring 1260			
Ford	F-350 (4x2, 4x4)	05-11	Rear

The Firestone air accessory systems provide an instant air source for all air suspension products. Simply flip a switch and adjust the ride for various load and road conditions. We also carry air accessory service parts and individual components, providing you with a wide variety of air control assist solutions. See page 50 for compressor technical data.

Standard Duty

Level Command II



Part No.
2158
Single
White Face
Gauge

The Level Command II utilizes a standard duty compressor (9284) and a single gauge (2229).
Inflates two bags equally.

Dual Electric Air Command



Part No.
2178
Dual
White Face
Gauge

The Dual Electric Air Command provides front-to-rear or side-to-side leveling through the use of an electric switch, dual gauge (2260) and standard duty compressor (9284).
Inflates two bags individually.

Standard Duty Digital

Digital Air Command I



Part No.
2490
Single
Digital
Gauge

The Digital Air Command I kit provides fingertip control of your air springs using a standard duty compressor (9377).
Inflates two bags equally.

Digital Air Command II



Part No.
2491
Dual
Digital
Gauge

The Digital Air Command II kit provides fingertip control of your air springs using a standard duty compressor (9377).
Inflates two bags individually.

Wireless

Wireless Air Command

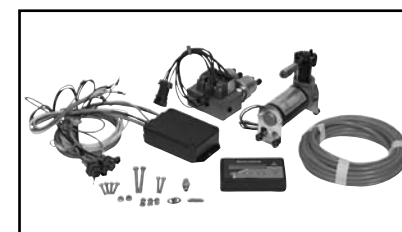

Part No.
2489
Dual
2500
Quad
Digital
Gauge
2501
Dual To
Quad
Upgrade

The Wireless Air Command kit provides fingertip control of your air springs using a standard duty compressor (9377).

• DO NOT EXCEED THE VEHICLE'S RECOMMENDED GROSS VEHICLE WEIGHT RATING (GVWR)

Wireless Air Command Generation II



Part No.
2540
(Heavy Duty)
Dual
Gauge
2541
(Standard Duty)
Dual
Gauge

The Wireless Air Command Generation II kits provide front-to-rear or side-to-side leveling through the use of an electric switch, dual gauge (2260) and compressor. The **2540** kit uses a heavy duty compressor (9285) with a gauged accessory port to inflate an accessory/tire. The **2541** kit uses a standard duty compressor (9377) and does not have an accessory port.
Both kits inflate two bags individually.
(available after 1/1/2011)

Heavy Duty

Level Command



Part No.
2097
Single
White Face
Gauge

The Level Command kit provides fingertip control of your air springs using a heavy duty compressor (9285).
Inflates two bags equally.

Dual Air Command II



Part No.
2168
Dual
White Face
Gauge

The Dual Air Command II provides front-to-rear or side-to-side leveling through the use of a dual gauge (2241), heavy duty compressor (9285) and 1/2 gallon air tank (9124).
Inflates two bags individually.

Dual Electric Air Command II



Part No.
2219
Dual
White Face
Gauge

The Level Command II kit provides front-to-rear or side-to-side leveling through the use of an electric switch, dual gauge (2260) and heavy duty compressor (9285).
Inflates two bags individually.

Air Command



Part Nos.
2047 -
1/2 gallon
tank
2232 -
1 gallon tank

The Air command provides an on-board air source for the Firestone air helper springs and other pneumatic components using our heavy duty compressor (9285), 1/2 (9124) or 1 gallon (9125) air tank and a 25' extension hose. This system can be used with both Automatic Air systems (2186 & 2017).

Super Heavy Duty

Dual Air Command III



Part No.
2198
Dual
White Face
Gauge

The Dual Air Command III provides front-to-rear or side-to-side leveling through the use of a dual gauge (2241), super heavy duty compressor (9230) and one gallon air tank (9125).
Inflates two bags individually.

Automatic Air

Single/Dual Automatic Air Command



Part Nos.
2186
One Leveling
Valve
2017
Two Leveling
Valves

The Single Automatic Air Command (2186) uses a height control valve. **Inflates two bags equally.** The Dual Automatic Air Command (2017) uses two height control valves mounted between the chassis and suspension.
Inflates two bags individually.

Fill Station

Remote Fill Station



Part No.
2239
Dial Gauge
& Inflation
Wand

The Remote Fill Station offers an on-board air source for inflating air springs, tires and other pneumatic components. Includes a heavy duty compressor (9285), 3 gallon air tank and a 25' extension hose with inflation wand (2311).

9377



9284



9335



9285



9230 • 9270



9164



Air Compressor Description	Maximum Air Pressure	Duty Cycle	Amperage Draw	0 - 30 PSI*	0-60 PSI*	Part No.
Standard Duty Air Compressor (Not for use with air tanks)	120 PSI (8.3 BAR)	9%	11 AMPS	17 sec.	42 sec.	9377
Standard Duty Air Compressor (Up to 1 gallon tank)	130 PSI (9.0 BAR)	15%	18 AMPS	13 sec.	30 sec.	9284
Heavy Duty Air Compressor (Up to 3 gallon tank)	145 PSI (10.0 BAR)	35%	17 AMPS	10 sec.	24 sec.	9335
Super Heavy Duty Air Compressor (Up to 5 gallon tank)	150 PSI (10.4 BAR)	30%	15 AMPS	10 sec.	24 sec.	9285
Super Heavy Duty Air Compressor (Up to 5 gallon tank)	150 PSI (10.4 BAR)	35%	18 AMPS	10 sec.	26 sec.	9230
High Duty Air Compressor (Up to 5 gallon tank)	120 PSI (8.3 BAR)	70%	15 AMPS	10 sec.	24 sec.	9270
Ultimate Duty Air Compressor (Up to 6 gallon tank)	100 PSI (6.9 BAR)	100%	26 AMPS	-	-	9164
Ultimate Duty Air Compressor (Up to 6 gallon tank)	150 PSI (10.4 BAR)	100%	19 AMPS	7 sec.	18 sec.	9287

*Indicates flow rate - how long it takes to fill 1/2 gallon air tank.

TECH TIP

All Firestone compressors are direct drive compressors (no oil or belts). This means the compressor can be mounted in any position without detriment to it. Compressors should be mounted in a clean air location.

2497



No Drill Air Compressor Mount To Frame
WR1-760-2497
Ideal for Compressor Only Mounting
Will Fit Kits:
WR1-760-2097
WR1-760-2158
WR1-760-2178
WR1-760-2219

2529



No Drill Digital/Wireless Air Command Frame Mount
WR1-760-2529
Ideal For Kits With Compressor & Valve Blocks
Will Fit Kits:
WR1-760-2489
WR1-760-2490
WR1-760-2491
WR1-760-2500
WR1-760-2097
WR1-760-2158
WR1-760-2178
WR1-760-2219

2530



No Drill Combo (Compressor Kit With Tank) Mount To Frame
WR1-760-2530
Will Fit Kits:
WR1-760-2047
WR1-760-2168
WR1-760-2198
WR1-760-2232
WR1-760-2239

Firestone continues to raise the bar on high pressure and high quality air springs with our **RED LABEL™** edition. This design is the result of over two years of strenuous testing to exceed the demands of those who require higher pressures to support and raise their vehicles. The air spring utilizes a proprietary high strength cord with excellent flexibility and durability while operating up to 150 PSI and having a test pressure of 400 PSI. Available in both our popular 267C 1.5 and 224 sizes and in 3/8 and 1/2 NPT port sizes. The Red Label parts are not intended to supplement the standard air springs in the Ride-Rite kits. The Red Label parts are intended for use on custom applications only.



1/8 NPT=.33" 1/4 NPT=.46" 3/8 NPT=.58" 1/2 NPT=.72" 3/4 NPT=.92"

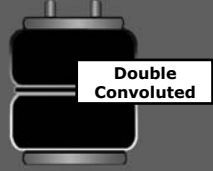
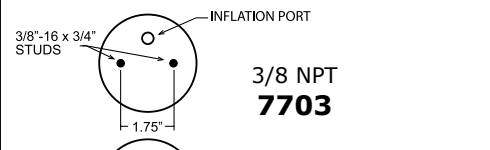
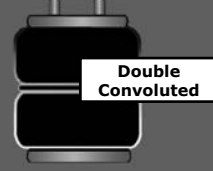
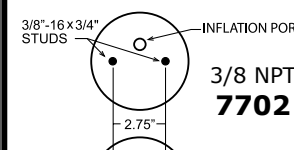
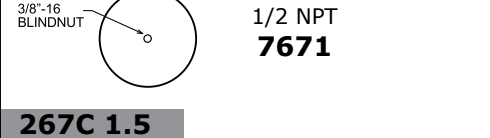
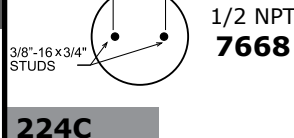

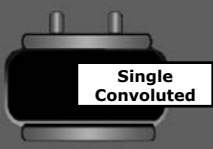
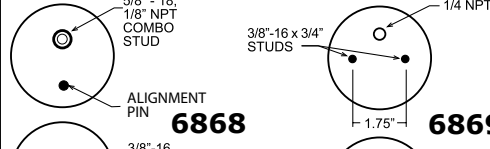
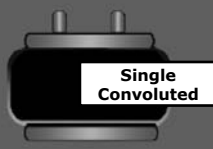
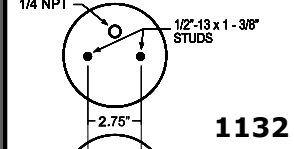
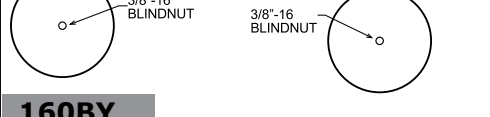
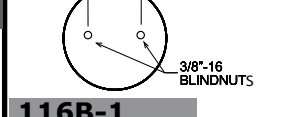

Red Label™ - High Pressure Air Springs - up to 150 PSI

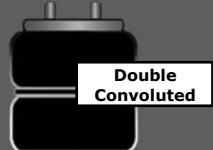
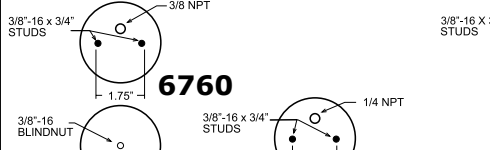
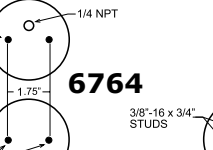
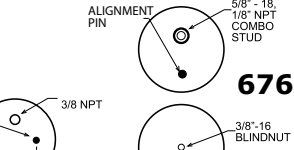
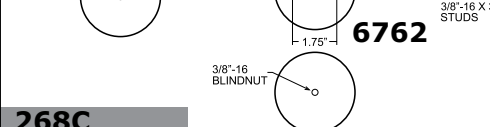
 <p>Double Convoluted</p>	 <p>INFLATION PORT 3/8" NPT 7703</p>	 <p>Double Convoluted</p>	 <p>INFLATION PORT 3/8" NPT 7702</p>
	 <p>3/8"-16 BLINDNUT 1/2 NPT 7671</p>		 <p>3/8"-16 x 3/4" STUDS 1/2 NPT 7668</p>
<p>Compressed Height 2.80" Extended Height 8.30" Ride Height 5.50"- 6.50" Max. Diameter 6.60"</p>	<p>267C 1.5</p>	<p>Compressed Height 3.00" Extended Height 8.91" Ride Height 5.50"- 7.00" Max. Diameter 7.52"</p>	<p>224C</p>



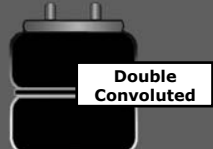
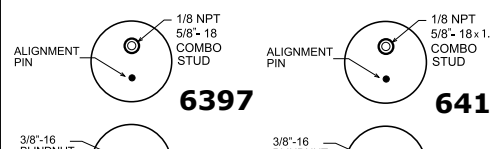
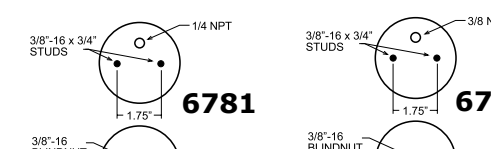

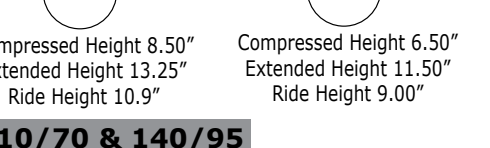
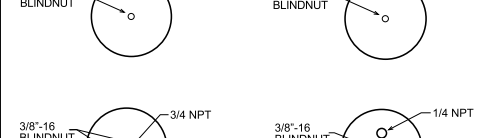
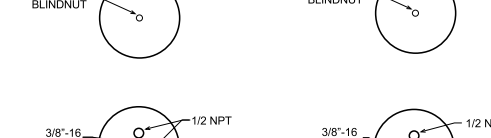

Standard Air Springs - up to 100 PSI

 <p>Single Convoluted</p>	 <p>5/8" - 18, 1/8" NPT COMBO STUD ALIGNMENT PIN 6868</p>	 <p>Single Convoluted</p>	 <p>1/4 NPT 1/2"-13 x 1-3/8" STUDS 6869</p>
	 <p>3/8"-16 x 3/4" STUDS 3/8"-16 BLINDNUT 160BY</p>		 <p>3/8"-16 BLINDNUTS 1132</p>
<p>Compressed Height 3.00" Extended Height 6.50" Ride Height 5.00"- 6.00" Max. Diameter 7.20"</p>	<p>160BY</p>	<p>Compressed Height 2.10" Extended Height 7.50" Ride Height 5.00"- 6.00" Max. Diameter 9.20"</p>	<p>116B-1</p>

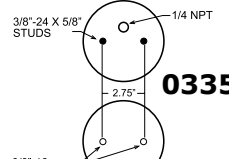
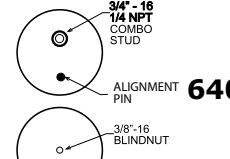
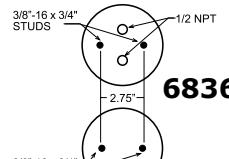
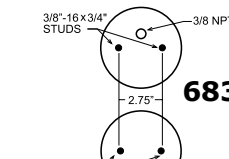
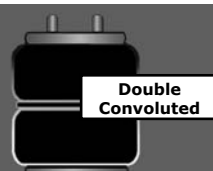
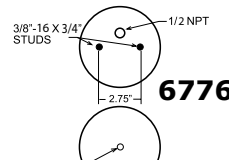
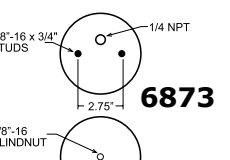
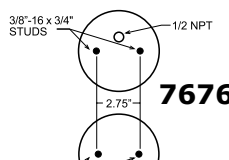
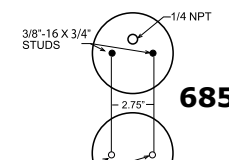
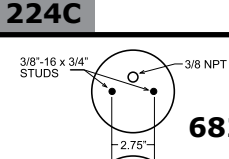
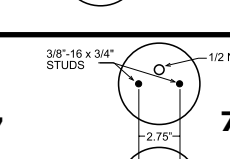
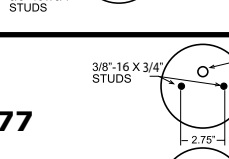
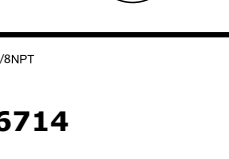
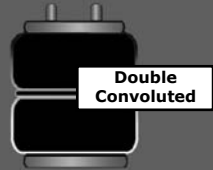
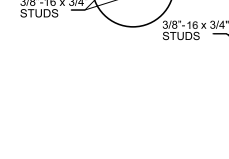
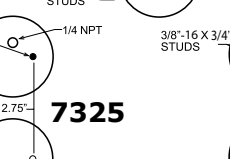
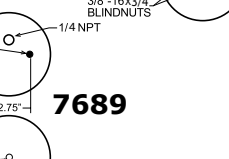
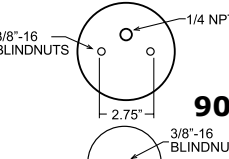
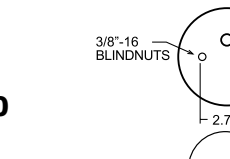
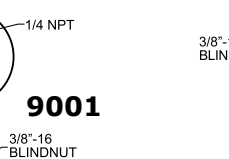
 <p>Double Convoluted</p>	 <p>3/8" NPT 3/8"-16 x 3/4" STUDS 1.75" 6760</p>	 <p>Double Convoluted</p>	 <p>1/4 NPT 3/8"-16 x 3/4" STUDS 1.75" 6764</p>
	 <p>3/8"-16 BLINDNUT 3/8"-16 x 3/4" STUDS 1.75" 6762</p>		 <p>3/8" NPT 3/8"-16 x 3/4" STUDS 1.75" 6765</p>
<p>Compressed Height 2.80" Extended Height 7.00" Ride Height 4.50"- 5.50" Max. Diameter 6.40"</p>	<p>268C</p>	<p>Compressed Height 2.80" Extended Height 7.00" Ride Height 4.50"- 5.50" Max. Diameter 6.40"</p>	<p>268C</p>

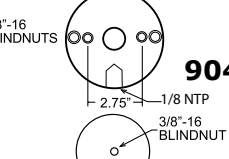
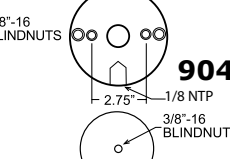
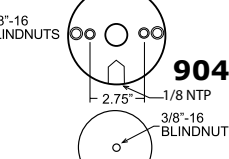
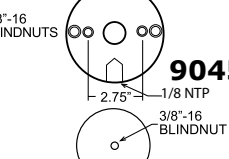
 <p>Double Convoluted</p>	 <p>ALIGNMENT PIN 1/8 NPT 5/8" - 18 COMBO STUD 6397</p>	 <p>ALIGNMENT PIN 1/8 NPT 5/8" - 18 x 1.75" COMBO STUD 6410</p>	 <p>1/4 NPT 3/8"-16 x 3/4" STUDS 1.75" 6781</p>	 <p>3/8" NPT 3/8"-16 x 3/4" STUDS 1.75" 6782</p>
	 <p>3/8"-16 BLINDNUT 3/4 NPT 1.75" 6783</p>	 <p>3/8"-16 BLINDNUT 1/4 NPT 1.75" 6784</p>	 <p>3/8"-16 STUDS 1/2 NPT 1.75" 6786</p>	 <p>3/8"-16 STUDS 1/2 NPT 1.75" 7882</p>
<p>Compressed Height 2.80" Extended Height 8.30" Ride Height 5.50"- 6.50" Max. Diameter 6.60"</p>	<p>267C1.5</p>	<p>Compressed Height 2.80" Extended Height 8.30" Ride Height 5.50"- 6.50" Max. Diameter 6.60"</p>	<p>267C1.5</p>	<p>Compressed Height 2.80" Extended Height 8.30" Ride Height 5.50"- 6.50" Max. Diameter 6.60"</p>

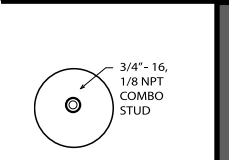
Standard Air Springs

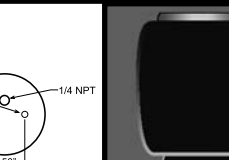
 <p>3/8"-24 x 5/8" STUDS 1/4 NPT 2.75" 0335</p>	 <p>3/4" - 16 1/4 NPT COMBO STUD ALIGNMENT PIN 3/8"-16 BLINDNUT 6401</p>	 <p>3/8"-16 x 3/4" STUDS 1/2 NPT 2.75" 6836</p>	 <p>3/8"-16 x 3/4" STUDS 3/8" NPT 2.75" 6837</p>	 <p>Double Convoluted</p> <p>Compressed Height 3.00" Extended Height 8.91" Ride Height 5.50"-7.00" Max. Diameter 7.52"</p>
 <p>3/8"-16 x 3/4" STUDS 1/2 NPT 2.75" 6776</p>	 <p>3/8"-16 x 3/4" STUDS 1/4 NPT 2.75" 6873</p>	 <p>3/8"-16 x 3/4" STUDS 1/2 NPT 2.75" 7676</p>	 <p>3/8"-16 x 3/4" STUDS 1/4 NPT 2.75" 6859</p>	
 <p>224C</p>	 <p>3/8"-16 x 3/4" STUDS 3/8" NPT 2.75" 6827</p>	 <p>3/8"-16 x 3/4" STUDS 1/2 NPT 2.75" 7677</p>	 <p>3/8"-16 x 3/4" STUDS 3/8" NPT 2.75" 6714</p>	 <p>Double Convoluted</p> <p>Compressed Height 3.00" Extended Height 9.00" Ride Height 7.00"- 8.00" Max. Diameter 8.60"</p>
 <p>3/8"-16 x 3/4" STUDS 1/4 NPT 2.75" 7325</p>	 <p>3/8"-16 x 3/4" STUDS 1/4 NPT 2.75" 7689</p>	 <p>3/4" - 16 1/4 NPT COMBO STUD ALIGNMENT PIN 3/8"-16 BLINDNUTS 2.75" 7701</p>		
 <p>3/8"-16 BLINDNUTS 1/4 NPT 2.75" 9000</p>	 <p>3/8"-16 BLINDNUTS 1/4 NPT 2.75" 9001</p>	 <p>3/8"-16 BLINDNUTS 1/4 NPT 2.75" 9002</p>	 <p>Tapered Sleeve</p> <p>Compressed Height 3.00" Extended Height 9.00" Ride Height 7.00"- 8.00" Max. Diameter 8.60"</p>	
<p>Compressed Height 6.25" Extended Height 10.25" Ride Height 8.25"</p>	<p>Compressed Height 4.37" Extended Height 8.37" Ride Height 6.38"</p>	<p>Compressed Height 5.25" Extended Height 9.25" Ride Height 7.25"</p>		
 <p>3/8"-16 BLINDNUTS 1/8 NPT 2.75" 9041</p>	 <p>3/8"-16 BLINDNUTS 1/8 NPT 2.75" 9042</p>	 <p>3/8"-16 BLINDNUTS 1/8 NPT 2.75" 9043</p>	 <p>3/8"-16 BLINDNUTS 1/8 NPT 2.75" 9045</p>	<p>See specs at left. Max. Diameter 5.70" (9000, 9001, 9002) Max. Diameter 6.44" (9041, 9042, 9043, 9045)</p>
<p>Compressed Height 8.50" Extended Height 13.25" Ride Height 10.9"</p>	<p>Compressed Height 6.50" Extended Height 11.50" Ride Height 9.00"</p>	<p>Compressed Height 6.90" Extended Height 12.75" Ride Height 9.84"</p>	<p>Compressed Height 7.90" Extended Height 12.60" Ride Height 10.25"</p>	
<p>110/70 & 140/95</p>				 <p>Reversible Sleeve</p> <p>Compressed Height 5.80" Extended Height 15.75" Ride Height 10.50" Max. Diameter 9.10"</p>
 <p>3/4" - 16, 1/8 NPT COMBO STUD 3/8"-16 BLINDNUT 7076</p>	 <p>3/8"-16 BLINDNUTS 1/4 NPT 3.50" 1/2"-13 BLINDNUT 2107</p>	 <p>3/8"-16 BLINDNUTS 1/4 NPT 3.50" 1/2"-13 BLINDNUT 5405</p>		
<p>70mm</p>	<p>Compressed Height 3.95" Extended Height 10.50" Ride Height 7.00" Max. Diameter 5.00"</p>	<p>1T14C1</p>	<p>Compressed Height 4.25" Extended Height 13.60" Ride Height 9.80" Max. Diameter 9.10"</p>	<p>1T14C3</p>

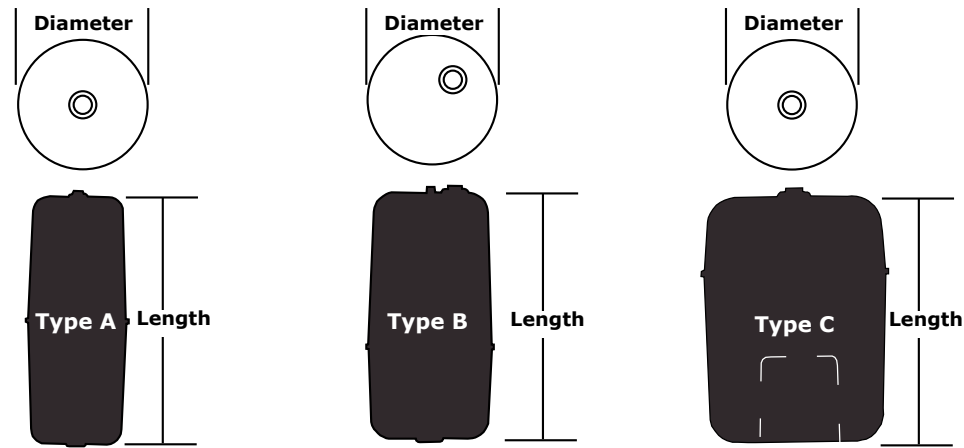

Coil-Rite Spring	Diameter	Length	Type
6000	3.56"	10.50"	A
6002	4.00"	11.00"	B
6003	4.75"	10.00"	A
6004	4.75"	6.50"	C
6005	5.50"	5.00"	A
6006	5.50"	7.00"	A
6007	5.50"	8.00"	A
6008	5.50"	9.00"	A
6009	5.50"	10.00"	A
6010	5.50"	11.00"	A
6011	4.00"	8.00"	B
6012	4.00"	4.00"	A
6013	4.00"	5.00"	A
6014	4.00"	9.00"	A
6015	4.00"	9.00"	A
6016	4.00"	10.00"	A
6017	4.75"	4.00"	A
6018	4.00"	7.00"	A
6019	4.00"	12.00"	A
6020	4.75"	6.50"	A
6021	4.75"	9.00"	A
6022	4.75"	13.00"	A
6023	4.75"	12.00"	A
6024	4.75"	7.50"	A
6025	4.00"	11.00"	A
6026	3.56"	8.75"	A
6027	3.56"	7.00"	A
6028	4.00"	6.00"	A
6030	4.38"	11.00"	A

Lift spacers can be used with most Ride-Rite™ air helper spring kits - NOT Coil-Rite™ or Sport-Rite™. In order to ensure proper spacer usage, determine the distance between the upper and lower brackets of your air helper spring kit, and whether the kit mounts on the leaf spring or the axle. The spacer needs to be the same length as the amount of lift applied to the axle on which the air helper spring is being installed.

- Axle Mount - Lower bracket attaches to the axle
- Leaf Mount - Lower bracket attaches to the leaf stack

The lifted and lowered vehicle applications come complete with the necessary brackets, air springs, fittings and inflation valves for manual inflation.

Lift Spacers	Air Spring Spacer Identification			
	part numbers are for a pair of spacers			
	Lift	Distance Between Brackets	Axle Mount No.	Leaf Mount No.
	2"	7.5" - 8.5"	2366	2366
	3"	8.5" - 9.5"	2368	2367
	4"	9.5" - 10.5"	2371	2370
	5"	10.5" - 11.5"	2373	2372
	6"	11.5" - 12.5"	2375	2374

Axle Extension Brackets for Lifted Vehicles		
	Kit Number	Lifted Distance
	2506	2"
	2507	3"
	2508	4"
	2509	5"
	2510	6"

Lifted Applications • lifted leaf springs /3"-4" only				
	Make/Model	Year	Rear Kit	Air Spring
	Chevrolet C&R - 10,20,30,3500 (4x2 only)	73-87	2264*	6781
	Dodge Ram 1500 (4x2, 4x4)	77-01	2264*	6781
	Dodge Ram 2500, 3500 (4x2, 4x4)	77-02	2264*	6781
	Ford Bronco Full Size (4x4)	90-96	2264*	6781
	Ford F-100, F-150, 5-250, F-350 Pickups (4x2, 4x4)	63-96	2264*	6781
	Ford F-250, F-350 Over 8500 GVWR (4x2, 4x4)	97-10	2264*	6781

Lowered Applications				
	Make/Model	Year	Rear Kit	Air Spring
	Chevrolet C-1500 (w/c notch & axle flip) (4x2 only)	88-98	2252*	6762
	Chevrolet/GMC Blazer/Jimmy	82-02	2516	9001
	Chevrolet S-10	82-04	2516	9001
	Toyota Tacoma	95-04	2516	9001
	Dodge Ram 1500	69-01	2517	9001
	Ford F-100, F-150	70-03	2517	9001
Chevrolet C-1500	88-98	2517	9001	
Chevrolet C-1500	93-10	2517	9001	

Minimum Tire to Frame Clearance Requirements: * = 7.50"

• DO NOT EXCEED THE VEHICLE'S RECOMMENDED GROSS VEHICLE WEIGHT RATING (GVWR)

Control Panels



Pneumatic
White Face 2225
Black Face 2149



Pneumatic
White Face 2241
Black Face 2145



Pneumatic
Black Face 2333



Monitoring Gauge
White Face 2196

Electric
White Face 2229
Black Face 2191

Electric
White Face 2260
Black Face 2188

Replacement Switches

Pneumatic 9074
Electric 9039

Wire Harness With Relay

9307



TECH TIP

Single control panels inflate and deflate one pair of air springs. Dual control panels inflate and deflate two individual air springs or two pairs. Pneumatic control panels are used in systems that utilize tanks. Electric control panels do NOT require a tank.

Accessories for Full-Air Suspensions







The Rapid Response System comes complete with two (2) heavy duty compressors, two (2) 3 gallon tanks, a quad control panel, 3/8" air line, a preassembled valve block, and a plug & play wire harness.

1/4" valves 2283 3/8" valves 2343

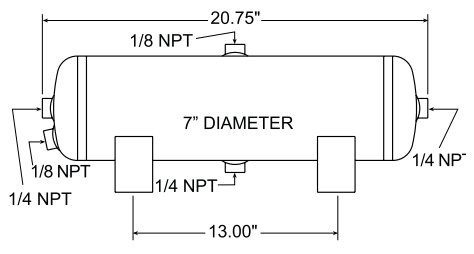
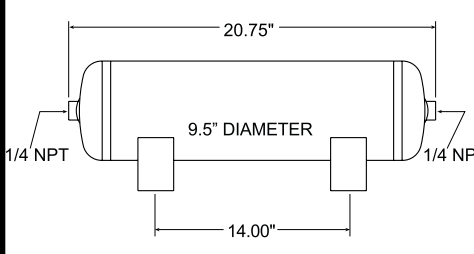
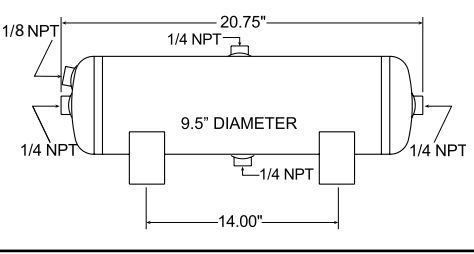
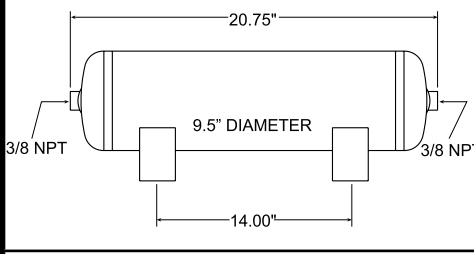
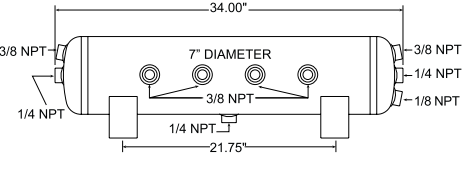
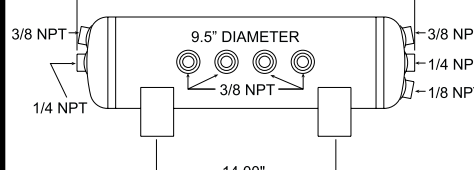
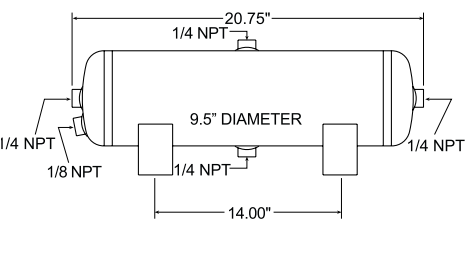
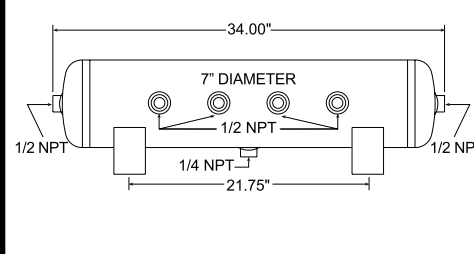
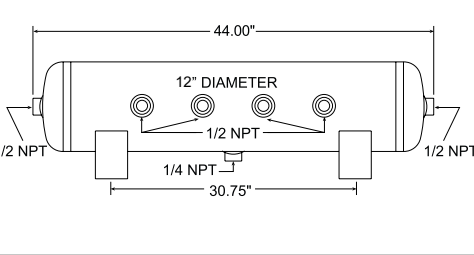
Firestone offers a wide selection of air tanks ranging from 1/4 gallon to 20 gallons. These air tanks are coated internally and externally to resist corrosion. They are tested to SAE J10 compliance and capable of 150 PSI maximum pressure.

1/4 Gallon Air Tank		1/2 Gallon Air Tank	
	Part No. 9166		Part No. 9124
1 Gallon Air Tanks			
	Part No. 9125		Part No. 9244
2 Gallon Air Tank		3 Gallon Air Tank	
	Part No. 9126		Part No. 9127
3 Gallon Air Tanks			
	Part No. 9148		Part No. 9227
	Part No. 9154		Part No. 9229

3 Gallon Air Tanks (cont.)		5 Gallon Air Tanks	
	Part No. 9245		Part No. 9191
5 Gallon Air Tanks			
	Part No. 9228		Part No. 9231
	Part No. 9242		Part No. 9243
	Part No. 9246		Part No. 9248
20 Gallon Air Tank		Tank Mounts	
	Part No. 9277		Part No. 2496
	Part No. 2497		Part No. 2530

Dealer Fitting Pack 1		Dealer Fitting Pack 2		Dealer Fitting Pack 3			
	Part No. 2359		Part No. 2360		Part No. 2395		
Description Includes 4 each: 1/4" union tees, inflation valves, 1/4 NPT elbow fittings		Description Includes 4 each: 1/4" union tees, inflation valves, 1/4 NPT elbow fittings and 2 each: 1/4" unions, 1/4 NPT straight fittings		Description Includes 6 each: 1/4 NPT elbow fittings, inflation valves - 2 each: union tees, 1/4 NPT straight fittings, union fittings. Also includes 100' of 1/4" D.O.T. air line tubing			
Ride-Rite™ / Sport-Rite™ Air Line Service Kit			Coil-Rite™ Air Line Service Kit				
	Part No. 2012	Description Includes 18' of red 1/4" air line, two 1/4 NPT elbow fitting, one union tee, and two inflation valves			Part No. 2131		
Description Includes 18' of blue 1/4" air line with attached elbow fittings, two inflation valves, tie wraps, and fasteners							
Air Line Tubing							
Size	Length (ft)	Color	Part No.	Size	Length (ft.)	Color	Part No.
1/4"	18	Red	0938	1/4"	30	Black	9153
1/4"	22	Red	0937	1/4"	1000	Black	9142
1/4"	30	Red	9008	3/8"	30	Black	9211
1/4"	100	Red	9145	3/8"	250	Black	9156
1/4"	1000	Red	2135	3/8"	1000	Black	9143
1/4"	18	Black	9151	1/2"	50	Black	9253
1/4"	22	Black	9152				
	Union Tee (Packages Of 25) 1/4" Tubing 3025 3/8" Tubing 3105 1/2" Tubing 3158			Male Branch Swivel Tee (Packages Of 25) 1/4" Tubing 3047 3/8" Tubing 3105 1/4 NPT 3273 3/8 NPT 3280 1/2" Tubing 3286 3/8 NPT 3287			
	Male Connector (Packages Of 25) 1/4" Tubing 3055 1/8 NPT 3055 1/4 NPT 3046 3/8 NPT 3267 3/8" Tubing 3277 1/4 NPT 3104 3/8 NPT 3154 1/2" Tubing 3157 1/2 NPT 3157			Male Elbow (Packages Of 25) 1/4" Tubing 3128 1/8 NPT 3128 1/4 NPT 3031 3/8" Tubing 3153 1/4 NPT 3103 3/8 NPT 3153 1/2" Tubing 3289 1/4 NPT 3290 3/8 NPT 3290 1/2 NPT 3156			
	Compressor Tee (Packaged Individually) 1/4" Tubing 1/8 NPT 3066			Inflation Valve (Packages Of 25) 1/4" Tubing 3032			
	Pressure Switch (Packaged Individually) 1/8 NPT Male 90-120 PSI 9016 100-150 PSI 9193			Straight Female (Packages Of 10) 1/4" Tubing 1/8 NPT 3082 1/4 NPT 3083			
	Sealed Pressure Switch (Packaged Individually) 90-120 PSI 9401 100-150 PSI 9402			Union (Packages Of 10) 1/4" Tubing 3079 1/4"- 3/8" Tubing 3114			
	Compressor Check Valve (Packages of 25) 1/8 NPT Male/Female 9399			Tubing Cutter (Packaged Individually) 9009			
	Ride-Rite Gloves (Packaged Individually) Small/Med. - 9345 Large - 9346						

